



UNESCO-IHE  
Institute for Water Education

# Groundwater Modelling and Optimization of Irrigation Water Use Efficiency to Sustain Irrigation in Kobo Valley, Ethiopia

Getahun Wendmkun Adane

MSc Thesis Number:WSE-HELWD-14.09

April 2014

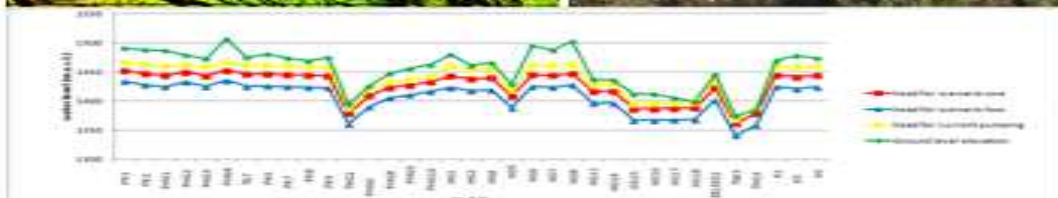
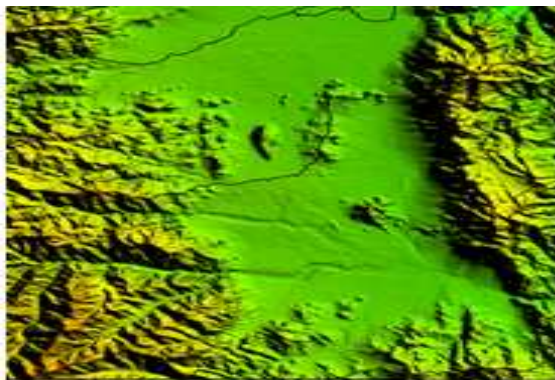



# **Groundwater Modeling and optimization of Irrigation water use efficiency to sustain irrigation in Kobo Valley, Ethiopia**

Master of Science Thesis  
by  
**Getahun Wendmkun Adane**

## Supervisors

Profes. Charlotte De Fraiture (PhD, MSc)

## Mentors

Abraham Mehari Haile (PhD, MSc)

## Examination committee

Profes. Charlotte De Fraiture ,PhD,MSc (UNESCO-IHE)  
Abraham Mehari Haile,PhD,MSc (UNESCO-IHE)  
F.Van Steenberg, PhD,MSc (Meta Meta's Hertogenbosch)

This research is done for the partial fulfilment of requirements for the Master of Science degree at the UNESCO-IHE Institute for Water Education, Delft, the Netherlands

**Delft**  
**April 2014**



©2014by Getahun Wendmkun Adane. All rights reserved. No part of this publication or the information contained herein may be reproduced, stored in a retrieval system, or transmitted in any form or by any means, electronic, mechanical, by photocopying, recording or otherwise, without the prior permission of the author. Although the author and UNESCO-IHE Institute for Water Education have made every effort to ensure that the information in this thesis was correct at press time, the author and UNESCO-IHE do not assume and hereby disclaim any liability to any party for any loss, damage, or disruption caused by errors or omissions, whether such errors or omissions result from negligence, accident, or any other cause.



# Abstract

Agriculture, Industry and domestic activities use enormous of water which results in the over-pumping and leading to continuous decline of groundwater level. Farmers often fail to satisfy the required soil moisture conditions for growing crops due to erratic low rainfall distribution. Poor on-farm water management practices resulted in excessive use and this leads to high energy cost. This study mainly focuses on groundwater modelling of kobo valley so as to predict the current and future groundwater level under different hydrologic and pumping scenarios. Aqua crop model was also used as a tool for assessing crop and water productivity under irrigated agriculture - the main production system in Kobo valley, the main study area of this research, located in Northern Ethiopia is enclosed by high mountain ranges on the edge of Afar Rift system and measures about 1200km<sup>2</sup> area. It has two main sub-basins, Hormat-Golina and Waja-Golesha that are characterized by high abundant resources with respect to groundwater, fertile land and livestock potential.

The groundwater flow system in unconsolidated deposit of Kobo valley was modelled using MODFLOW (McDonald and Harbaugh, 1988). The model was run for steady-state conditions in unconfined and confined aquifer. The grid cell size of the model was taken 300 x 400m and contains two layers. Model area and the layer top elevation were delineated by the ASTER DEM processing and use of topographic maps. The hydraulic conductivity values were determined from pumping test data analysis and literature review for the alluvial sediment aquifer and the fractured volcanic aquifer respectively. Recharge was estimated from water balance and Darcy's approach method and has a value of 95MCM and 83 MCM respectively. The model was calibrated using observed hydraulic heads from 35 wells from Hormat-Golina sub-basin using trial and error method and resulted in a Root Mean Square Error (RMSE) value of about 7m, which is considered to be good and an indicator of reliable model results. The model simulated water budget showed that the valley receives a total recharge of 118MCM /year. The steady state model with pumping scenarios:- current scenario (11 wells are operated simultaneously), scenario-one (35 wells are operated simultaneously) & scenario-two (70 wells are operated simultaneously) indicated respective groundwater abstraction of 5192 m<sup>3</sup>d<sup>-1</sup>, 27878 m<sup>3</sup>d<sup>-1</sup> and 55825 m<sup>3</sup>d<sup>-1</sup>. This resulted in an average groundwater level decline (at the pumping well) of about 7m, 14m and 32m respectively. A maximum of 35 wells simultaneous operation is recommended as this will maintain a 20% stabilized drawdown, which results in a balance between abstraction and recharge.

The current irrigation system is operating at an efficiency of 55% as the actual amount of water applied is about 730 mm while the net requirement obtained from Aqua Crop is 404 mm. Under groundwater based irrigation, the efficiency could be improved to 80% through the use of piped conveyance canals and good field water distribution that reduces runoff and deep percolation losses. Under the current actual harvest by the farmers of 1.8 ton/ha, and assuming only the fuel cost, the difference in net income between operating at 55% and 80% efficiency is 109 Euros/ha. If, however, the yield could be improved to 4.7 ton/ha (this yield is obtained by farmers in others regions of Ethiopia), the difference in net income is nearly 1000 Euros/ha.

Key words: Kobo valley, Groundwater modelling, Recharge, Aqua Crop model, Irrigation water use efficiency





# Acknowledgements

I would like to express my deepest gratitude to the Government of Netherlands through Netherland Fellowship programme (NFP) and IFAD for grating me the chance to study Master of Science degree at UNESCO-IHE.

I greatly thank my mentor Abraham Mehari Haile (PHD) for his excellent guidance and encouragements. I highly appreciate his constructive advice and fruitful comments. Special thanks go to my supervisor Prof. Charlotte De Frature for her special comments as well as Suryadi (PHD) for his technical support in Groundwater modelling.

I gratefully acknowledge all Amhara Water Work Construction Workers especially kobo project. There is no proper word for Mr.Alelegn Yesuf; Kobo project manager, Mr.Ermiya, Mr. Amhayes Zewudu, Mr. Mohammed Ebrahim, Mr.Jemal, Mr.Birhanu, Mr.Tilahun Mekonen and Mr.Alemu for their special help during field work activities. I thank you all. I also thank Mr.Nafiyad and Mr.Wassiyte Abate for their help in Groundwater modelling and data collection in Addis Ababa.

My deepest gratitude must go to my sister, Genzebua Fentaw for her encouragement and support in my academic life.

Finally, I offer my deepest gratitude and appreciations to my family and friends for their support and love throughout my life.



# Table of Contents

<b>Abstract</b>	<b>i</b>
<b>Acknowledgements</b>	<b>iii</b>
<b>List of Figures</b>	<b>vii</b>
<b>List of Tables</b>	<b>viii</b>
<b>Abbreviations</b>	<b>ix</b>
<b>1. Introduction</b>	<b>1</b>
1.1. Back ground	1
1.2. Problem statement	2
1.3. Objectives of the Research	2
1.4. Research questions	2
1.5. Possible scenarios	2
1.6. Methodology	2
1.7. Outline of the thesis.	4
<b>2. 2.Literature Review</b>	<b>6</b>
2.1. Review of previous study	6
2.2. Groundwater Modelling	7
<b>3. General description of the study area</b>	<b>9</b>
3.1. Location	9
3.2. Drainage	10
3.3. Climate	10
3.4. Land use and cover	10
3.5. Geology and Hydrogeology	10
3.5.1. Geology	10
3.5.2. Hydrogeology	12
<b>4. Analysis and Model input data preparation</b>	<b>13</b>
4.1. Meteorological data Analysis	13
4.1.1. Rainfall	13
4.1.2. Temperature	15
4.1.3. Wind speed	16
4.1.4. Solar Radiation	16
4.1.5. Evapotranspiration (ET <sub>o</sub> )	16
4.2. Groundwater recharge estimation	18
4.2.1. Water Balance Method	18
4.2.2. Darcy Approach	19
4.3. Pump test data Analysis.	19
<b>5. Groundwater Modelling of Kobo Valley</b>	<b>21</b>
5.1. Introduction	21

5.1.1.	The modelling Process	21
5.2.	Conceptual Model	22
5.2.1.	Boundary Conditions	24
5.2.2.	Stratigraphic Units	24
5.2.3.	Sources and sinks of the Model area	24
5.2.4.	The Model area	28
5.2.5.	Aquifer Geometry	28
5.3.	Numerical Model	29
5.3.1.	Data input for the Model	29
5.3.2.	Model execution and Calibration	30
5.3.3.	Calibration target and Uncertainty	30
5.3.4.	Trial and Error Calibration	30
5.3.5.	Evaluation of calibration	31
<b>6.</b>	<b>Result and Discussion</b>	<b>33</b>
6.1.	Results	33
6.1.1.	Water Budget of the model domain	33
6.1.2.	Sensitivity Analysis	33
6.1.3.	Pumping Scenario Analysis	34
6.1.4.	Estimation of Radius of influence and well interference	38
6.1.5.	Groundwater Reserve in Kobo Valley	40
6.1.6.	Estimation of Allowable Exploitation of Groundwater	41
6.1.7.	Irrigation Water use efficiency	42
6.1.8.	Aqua crop Model to determine seasonal water requirement	42
6.1.9.	Pumping Cost.	45
6.2.	Discussions	47
6.2.1.	Water Balance Method and Darcy's Approach	47
6.2.2.	Groundwater modelling	47
6.2.3.	Water budget of the model domain	48
6.2.4.	Pumping Scenario	48
6.2.5.	Radius of Influence and well interference	48
6.2.6.	Groundwater reserve and allowable exploitation	48
6.2.7.	Aqua Crop model	48
6.2.8.	Model Limitation	49
6.2.9.	Groundwater model and Aqua crop model	49
<b>7.</b>	<b>Conclusion and Recommendation</b>	<b>50</b>
7.1.	Conclusion	50
7.2.	Recommendation	51
Appendix A	Metrological Data	54
Appendix B	Pump Test Data	61
Appendix C	Error evaluation	65
Appendix D	Groundwater Abstraction	66
Appendix E	Radius of influence and drawdown	72

# List of Figures

<b>Figure 1.1</b>	Groundwater level measuring using deep meter at PK8 borehole.....	3
<b>Figure 1.2</b>	Taking bore location & elevation using GPS at K5 on left and river data around Golina river outlet on the right. ....	3
<b>Figure 1.3</b>	Flow chart of the methodology.....	5
<b>Figure 3.1</b>	Location map of the study area.....	9
<b>Figure 3.2</b>	Geology and structural map of Kobo-Girana Valley: source geological map of Ethiopia, 1996.....	11
<b>Figure 4.1</b>	Mean monthly rainfall of the stations (1996- 2010).....	14
<b>Figure 4.2</b>	Mean annual rainfalls of the stations .....	14
<b>Figure 4.3</b>	Kobo station annual rainfall (1996-2010).....	15
<b>Figure 4.4</b>	Mean Monthly Maximum Temperatures of Kobo & Korem Station .....	15
<b>Figure 4.5</b>	Mean monthly minimum temperature (oc) of Kobo and Korem.....	16
<b>Figure 4.6</b>	Mean monthly Wind speed of kobo .....	16
<b>Figure 4.7</b>	Precipitation (P), potential evapotranspiration (ETO) and average monthly Temperature ( $T_{avg}$ ) for Kobo station (1996 to2010) .....	17
<b>Figure 5.1</b>	Steps in modelling protocol (after Anderson and Woessner, 1992). ....	22
<b>Figure 5.2</b>	Schematic diagram illustrating the simplified conceptual model. ....	23
<b>Figure 5.3</b>	Simplified Conceptual model as taken from Global Mapper. ....	23
<b>Figure 5.4</b>	Golina river near the outlet to Afar. ....	25
<b>Figure 5.5</b>	Plan View of the Entire Modelled Area .....	28
<b>Figure 5.6</b>	Cross-Sectional View of the Model Area along Line North to South of Fig. 5-5 .....	29
<b>Figure 5.7</b>	Trial and error calibration procedures (adapted from Anderson and Woessner, 1992).....	30
<b>Figure 5.8</b>	Graphical comparison between the observed and simulated heads .....	31
<b>Figure 5.9</b>	The scatter diagram showing the comparison of measured and simulated heads.....	32
<b>Figure 6.1</b>	The model simulated groundwater heads for pumping scenario-one .....	35
<b>Figure 6.2</b>	The model simulated groundwater heads for pumping scenario-two .....	36
<b>Figure 6.3</b>	Comparison between the observed and simulated heads of different scenarios .....	37
<b>Figure 6.4</b>	The scatter plots of simulated versus observed heads for different pumping scenarios .....	38
<b>Figure 6.5</b>	well interference in Hormat-Golina sub-basin .....	39
<b>Figure 6.6</b>	Net irrigation requirement from Aqua Crop model. ....	43
<b>Figure 6.7</b>	Soil water balance from Aqua Crop model. ....	44
<b>Figure 6.8</b>	Soil water balance in generation of irrigation schedules. ....	45

# List of Tables

<b>Table 4.1</b>	Mean monthly rainfall distribution mm (1996-2010) .....	14
<b>Table 4.2</b>	Computed ETO of Kobo station using Penman-Monteith equation.....	17
<b>Table 4.3</b>	Darcy approach recharges estimation of Hormat-Golina and Waja-Golesha sub-basins .....	19
<b>Table 5.1</b>	The estimated amount of water abstracted from boreholes per annual .....	27
<b>Table 5.2</b>	Error summary for the calibrated model.....	32
<b>Table 6.1</b>	Water budget of the entire model domain in $m^3d^{-1}$ .....	33
<b>Table 6.2</b>	Estimated groundwater abstraction rate and the average decline in groundwater level for different pumping scenarios .....	34
<b>Table 6.3</b>	Simulated water budget of Kobo-valley for scenario-one in $m^3d^{-1}$ .....	37
<b>Table 6.4</b>	Simulated water budget of Kobo-valley for scenario-two in $m^3d^{-1}$ .....	37
<b>Table 6.5</b>	Well interference computation in Hormat-Golina sub-basin.....	40
<b>Table 6.6</b>	Groundwater reserve in Kobo valley .....	41
<b>Table 6.7</b>	Allowable abstraction for 60% drawdown of the saturated thickness in Kobo Valley .....	41
<b>Table 6.8</b>	Estimation of the Available Groundwater Potential and Number of Wells in Kobo Valley ..	41
<b>Table 6.9</b>	Cost- Analysis of pumping in well .....	45
<b>Table 6.10</b>	Pump detail.....	46
<b>Table 6.11</b>	Fuel cost-benefit analysis of Maize production.....	46
<b>Table 6.12</b>	Fuel cost-benefit analysis of optimized maize production .....	47
<b>Table A.1</b>	Monthly Rainfall (mm) at Kobo station .....	54
<b>Table A.2</b>	Monthly Rainfall (mm) at Alamata Station .....	54
<b>Table A.3</b>	Monthly Rainfall (mm) at Zoble Station .....	55
<b>Table A.4</b>	Monthly Rainfall (mm) at Korem station .....	55
<b>Table A.5</b>	Monthly Rainfall (mm) at Lalibela station .....	56
<b>Table A.6</b>	Monthly Tmax ( $^{\circ}c$ ) at Kobo station .....	56
<b>Table A.7</b>	Monthly Tmax. ( $^{\circ}c$ ) at Alamata Station .....	57
<b>Table A.8</b>	Monthly Tmax. ( $^{\circ}c$ ) at Korem station.....	57
<b>Table A.9</b>	Monthly Tmin. ( $^{\circ}c$ ) at Kobo station .....	58
<b>Table A.10</b>	Monthly Tmin. ( $^{\circ}c$ ) at Alamata station .....	58
<b>Table A.11</b>	Monthly Tmin. ( $^{\circ}c$ ) at Korem Station.....	59
<b>Table A.12</b>	Monthly average wind speed (m/s) at Kobo Station.....	59
<b>Table A.13</b>	Monthly average sunshine (hour) at Kobo station.....	60
<b>Table B.1</b>	Hydraulic parameters of the alluvial sediment aquifer .....	61
<b>Table C.1</b>	Comparison of the Observed and Simulated Heads and Error Calculation.....	65
<b>Table D.1</b>	The estimated amount of abstracted water used in scenario-one.....	66
<b>Table D.2</b>	The estimated amount of water abstracted from 70 boreholes in scenario-two.....	68
<b>Table D.3</b>	Estimating the decline groundwater level for scenario-one and scenario-two .....	71
<b>Table E.1</b>	Radius of influence and drawdown .....	72

# Abbreviations

ASTER	Advanced Space borne Thermal Emission and Reflection Radiometer
Co-SAERAR	Commission for Sustainable Agriculture and Environmental Rehabilitation in Amhara Region
DD	Drawdown
DEM	Digital Elevation Model
DWL	Dynamic Water Level
EIGS	Ethiopian Institute of Geological Survey
ET <sub>o</sub>	Potential Evapotranspiration
GES	Geo-Engineering Service
GIS	Geographic Information System
GPS	Global Positioning System
H <sub>m</sub>	Measured head
H <sub>s</sub>	Simulated head
KGVDP	Kobo-Girana Valley Development Project
m.a.s.l	Meter above sea level
MAE	Mean absolute error
ME	Mean error
MCM	Million Cubic Meters
RMS	Root mean square error
RVDP	Raya Valley Development Project
SCS	Soil Conservation Service
SRTM	Shuttle Radar Topographic Mission
SWL	Static Water Level

# List of Symbols

d	day
ET <sub>o</sub>	Potential Evapotranspiration (mm)
ET <sub>a</sub>	Actual Evapotranspiration (mm)
ha	hectare
I	Hydraulic gradient
k	Hydraulic conductivity (m/d)
K <sub>av</sub>	Average Hydraulic conductivity (m/d)
l	Liter
m	Meter
mm	Millimeter
°c	Degree centigrade
p	Annual precipitation
Q	Discharge (m <sup>3</sup> /d)
R	Recharge to groundwater
S	Soil moisture content
S <sub>r</sub>	Annual surface runoff
S <sub>y</sub>	Specific Yield
T	Transmissivity (m <sup>2</sup> /d)
T <sub>av</sub>	Average Transmissivity (m <sup>2</sup> /d)



# CHAPTER 1

## Introduction

---

### 1.1. Back ground

Groundwater is one of the most valuable natural resources, which supports human health, economic development, and ecological diversity. Because of its several inherent qualities (e.g., consistent temperature, widespread and continuous availability, excellent natural quality, limited vulnerability, low development cost, drought reliability), it has become an important and dependable source of water supplies in all climatic regions including both urban and rural areas of developed and developing countries (Todd, 2005). Of the 37 Mkm<sup>3</sup> of freshwater estimated to be present on the earth, about 22% exist as groundwater, which constitutes about 97% of all liquid freshwater potentially available for human use (Foster, 1998).

Approaches of sustainable development and integrated groundwater resources management must be developed and implemented to guarantee the right of use of the limited water resources for future generation. Groundwater resource management of an aquifer system involves developing a quantitative understanding of the flow processes that operate within the aquifer. Three main features must be considered: how water enters the aquifer system; how water passes through the aquifer system and how water leaves the aquifer system. The best tool available to help groundwater hydrologists to formulate technically-sound groundwater resources management is usually a groundwater model. Groundwater models have been used as interpretation tools for investigating groundwater system dynamics, assessment tools for evaluating recharge and quantifying sustainable yield (Anderson and Woessner, 1992).

Irrigation water increases crop yields and quality in semi-arid areas like Kobo, Northern Part of Ethiopia. It is essential especially during periods of erratic rain fall and drought. Since there is a declining groundwater resource, the main sources for irrigation in the study area. The irrigation water efficiency has to be increased as much as possible. The right amount of irrigation water has to be reached the right place at the right time in order to have effective irrigation.

Water efficiency of irrigation can be improved by making the right decision regarding to crop selection, irrigation scheduling and irrigation methods. The actual irrigation system capacity, the crop water demand is computed by Aqua crop model. This helps to reduce the amount of irrigation water pumped and avoid excessive energy use. Quantification of the actual irrigation water demand also provides critical information to the farmers, local groundwater conservation, Irrigation and regional water planning groups.

The study area mainly focuses on the two main sub-basin of Kobo valley named as Hormat-Golina and Waja-Golesha located in Northern Ethiopia. These sub-basins have a high groundwater potential and also known by semi-arid climate. Because of low and variable annual rainfall, groundwater irrigation is used to alleviate drought problem in the area but there is low attention given to groundwater resource management.

As observed from the field visit, history of bore holes are not recorded properly, no surface water gauging stations over the area and along the main rivers. However, for sustainability of groundwater resource, there should be safe abstraction and proper management.

In this thesis, numerical groundwater modelling of kobo valley using MODFLOW-version 8 for steady state condition has given higher priority in addition to optimization of irrigation water use efficiency in the area. Therefore clear understanding of the response of the aquifer is crucial for better management of groundwater resources.

## 1.2. Problem statement

Even though the kobo valley is rich in fertile soil for agricultural production, the lowland area has low rainfall which is insufficient for higher agricultural production. Due to erratic rainfall distribution in the area, the farmers often fail to satisfy the required soil moisture conditions for growing crops. Consequently, the area was affected by drought in a number of times. Now days, using ground water is growing continuously and increasingly being used as a main source of water for irrigation. However, there is no control or management of groundwater resources, hence developing ground water model is essential.

The kobo valley has a potential of over 10,000ha of land to irrigate however, the current irrigated land is less than 1000ha. Due to high energy cost for pumping water from wells and problem of on-farm water management, there is a need to optimize water use efficiency and maximize crop yield. Aqua crop program me is useful to determine the actual crop water requirement.

## 1.3. Objectives of the Research

- To quantify the recharge and abstraction of groundwater.
- To analyze the impacts or drawdown of wells under different well operation scenarios.
- To recommend on-farm water management for improving irrigation water use efficiency and minimize costs.

## 1.4. Research questions

- What is the recharge and abstraction of groundwater in the study area?
- What are the impacts or drawdown of wells under different well operation scenarios?
- How efficient is the current irrigation application system? How and to what extent can this be improved? And what will be the implication on reduction of pumping costs and the net income?

## 1.5. Possible scenarios

- ✚ Analysis of rainfall data (at least 15 year) to assess the variations in recharge and abstractions of groundwater.
- ✚ The impacts or drawdown in operating all the wells at its maximum discharge especially in concentrated wells at a time.
- ✚ The impacts or drawdown in operating wells by dividing in to two groups at different time.

## 1.6. Methodology

Appropriate methods and materials should be used in order to achieve the objectives stated above (section 1.3). The main activities can be classified in to pre-field, field and post-field works. All the three stages were illustrated in **Figure 1.3**.

## Pre-filed work

Data have been collected from different offices (Ethiopia National Meteorological Agency, Ministry of Water resource). Equipments like Groundwater level measuring device (deep meter) and GPS were taken from Amhara Water Work Construction Enterprise office and Kobo town water supply office respectively. Soil and crop data were taken from Kobo Girana Valley Development Project office. Delineation of the study area and literature review of groundwater modelling and irrigation water use efficiency was included in this stage.

## Field work

This stage was conducted in order to get primary data from the study area and secondary data from different sources. Measuring ground water level measuring using deep meter, taking reading of borehole locations and elevation using GPS, river out let and longitudinal data using Total stations, determination of physical boundaries were the main primary data conducted in the field.(see **Figure 1.1** and **Figure 1.2**). The secondary data such as borehole logs, pumping test data and hydrogeology feasibility report and well completion report were collected from Kobo-Girana Valley Development Project Office.



**Figure 1.1** Groundwater level measuring using deep meter at PK8 borehole



**Figure 1.2** Taking bore location & elevation using GPS at K5 on left and river data around Golina river outlet on the right.

## **Post -field work**

Data processing and analysis was the primary activity in this stage. Primary and secondary data was processed and analyzed in order to prepare database and conceptual model. The conceptual model was used for the core input for the modelling process.

Geographic Information System (GIS) was used to enter store, retrieve, and process and display spatial information in the form of maps or images. Advanced Space borne Thermal Emission and Reflection Radiometer (ASTER) DEM with 90m spatial resolution was processed to delineate the catchment.

## **1.7. Outline of the thesis.**

The content of the thesis is briefly outlined as follows;

Chapter one: Describes the introduction.

Chapter two: Discusses the review of previous studies.

Chapter three: Describes the study area.

Chapter four: Data processing and analysis.

Chapter five: Depicts the numerical modelling and deals with the pumping scenario analysis.

Chapter six: Deals Optimization of irrigation water use efficiency and Aqua crop Model.

Chapter seven: Results and discussion.

Chapter eight: Conclusion and Recommendation.

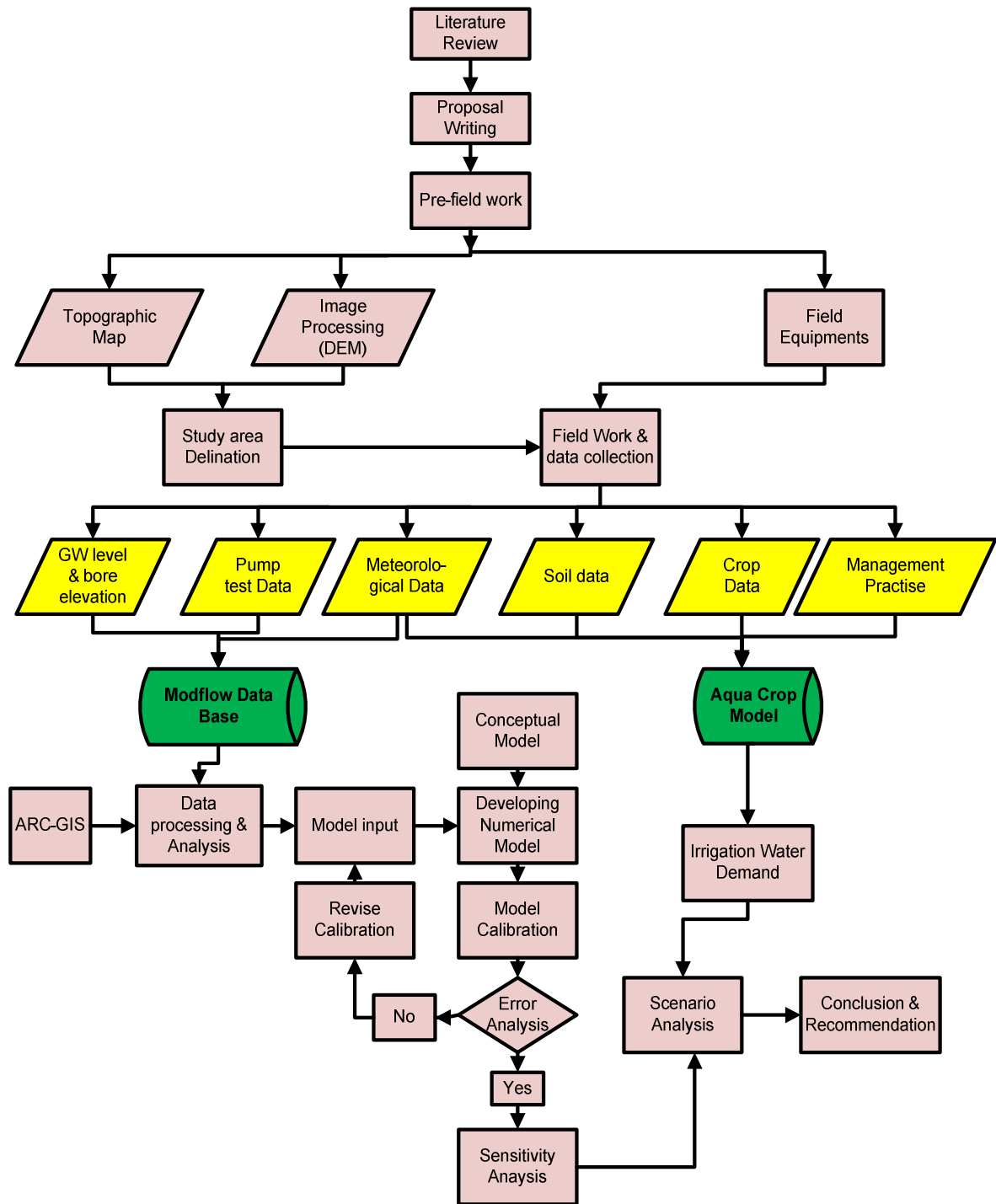

Figure 1.3 Flow chart of the methodology

## CHAPTER 2

# 2.Literature Review

---

### 2.1. Review of previous study

The kobo valley has been known as one of the most drought prone regions in Ethiopia. According to the historical analysis of rain fall, the major part of the valley once every decade is a drought year on the average. The groundwater potential for irrigation at the valley has been the focus since long due to the expected high groundwater potential. Following this, a number of studies were conducted on the physiographic setup, geology, tectonics and groundwater potential at different levels and localities in Kobo valley. The study area is one part of Kobo-Girana valley development project that mainly focus sustainable development to alleviate the drought and famine from the area.

Among the major studies conducted in Kobo-Girana valley are the investigations of groundwater potential for multipurpose by Co-SAERAR from 1996 to 1999 and review and appraisal of Hydro geological studies by Geo-Engineering Service in 2002/3.

#### **CO-SAERAR study**

The Commission for Sustainable Agriculture and Environmental Rehabilitation in Amhara Region (Co-SAERAR) studied the Kobo-Girana valley for its groundwater potential and then by implement irrigation through groundwater source (Co-SAERAR 1999).The study made preliminary estimation of annual recharge capacity of the Kobo, Alawha, Chireti and Gelana sub basins to be 119, 9, 15 & 27MCM, respectively. The deeply weathered and fractured zones of the volcanic rocks frequently exceed 100meters. Depth to groundwater varies from less than 20meters in the sediment deposit in the western part and along the river courses to over 100 meters in the volcanic rocks. The predominant groundwater flow direction is from west to east coinciding with topographic gradient. The hydraulic gradient of the Kobo basin is 0.012 (Co-SAERAR 1999). The groundwater recharge of the Kobo-Robit basin was estimated from three different methods. These are surface water balance method using SCS model, groundwater level fluctuation rate, and Darcy's approach; and the results were 59.3 MCM, 64.8 MCM and 49.82 MCM respectively. The surface water balance method, despite its crude and lumped inputs was found relatively to be comprehensive and practical to estimate the valley's recharge (Co-SAERAR 1999).

#### **EIGS study**

Hydro geological and environmental isotope investigations have been done by Sileshi Mamo from the Geological Survey of Ethiopia (2007), the total dynamic groundwater in the graben sediments estimated to amount 68.9MCM in Kobo valley. Recharge estimation using Chloride (Cl) mass balance has given recharge rates of 60.07 mm/year for the western plateau and 52.00 mm/year for the graben fill sediments

and adjoining escarpment. A total of 192.78 MCM/yr dynamic groundwater resource is estimated for the graben sedimentary aquifer; 123.89 and 68.9 MCM/yr for Raya and Kobo valleys, respectively (Sileshi Mamo, 2007).

## 2.2. Groundwater Modelling

A groundwater model may be defined as a simplified version of the real groundwater system that approximately simulates the excitation- response relations of the groundwater system. The real system is very complicated and difficult to use it directly for the purpose of planning and making management decisions. The simplification is introduced in the form of a set of assumptions that express our understanding of the nature of the system and its behaviour. These assumptions will tend to smooth out the effect of various heterogeneities. Because the model is a simplified version of the real system, there exists no unique model for a given groundwater system (Bear, 1979).

There are several ways to classify groundwater flow models, models can be transient or steady state and one, two, or three spatial dimensions. Steady state flow occurs when at any point in a flow field the magnitude and direction of the flow are constant with time (Anderson and Woessner, 1992).

Groundwater models are an attempt to represent the essential features of the actual groundwater system by means of a mathematical counterpart (Todd & Mays, 2005). These models have a capacity to test and quantify the consequences of various errors and related model-based forecasts. Groundwater models according to Todd are physically based mathematical models derived from Darcy's law and the law of conservation of mass. Various established solution techniques based upon either finite difference or finite element approximations, or a combination of both, are available for solving the governing equations of the model. The accuracy of the solutions (model predictions) is dependent upon the reliability of the estimated model parameters and the accuracy of the prescribed boundary conditions.

Computer program or code solves a set of algebraic equations generated by approximating the partial differential equations (governing equation, boundary conditions, and initial conditions) that form the mathematical mode (Anderson and Woessner, 1992). With the introduction of computers and their application in the solution of numerical models, physical models and analogy have become laid off as tools for predicting future groundwater regimes. The selection of the appropriate model to be used in any particular case depends on the objective or objectives of the investigation and the available resources. The later include time, budget, skilled manpower, high capacity computers and codes (Bear, 1979).

The finite difference method requires a rectangular element shaped discretization of the aquifer and the finite element method consists of a triangular discretization. Discretization is the process of subdividing the continuous hydro geologic units into discrete segments or cells. Finite element method is easy to define the boundaries of irregularly shaped aquifers and to ensure that node points coincide with monitoring wells or varies types of geographic features. The mathematical basis for finite element methods is more complex than for the finite difference method (Todd & Mays, 2005).

Selecting the appropriate conceptual model for a given problem is one of the most important steps in modelling process. The key data requirements in the process of conceptualization include data about hydro-stratigraphic units, surface water bodies, physical and hydraulic boundaries, recharge and discharge zones. The most common numerical methods to solve flow problems are finite differences and finite elements. Finite-difference grids are easy to understand and require less input data than finite element grids (Anderson and Woessner, 1992). The finite difference method, as applied in the computer code MODFLOW, was used in this study. The code is based on the physical theory of groundwater movement Darcy's law and the continuity equation. The program supports seven additional packages, which are integrated with the original MODFLOW (Chiang and Kinzelbach, 2001).

Once the conceptual model is translated into a numerical model in the form of governing equations, with associated boundary and initial conditions, a solution can be obtained by transferring it into a numerical model and writing a computer program (code) for solving it. This includes, design of grid, setting boundary

and initial conditions and preliminary selection of values for aquifer parameters. The input parameters include model grid size, layer elevations, boundary conditions, hydraulic conductivity, recharge, and additional model input for steady state condition. Model calibration consists of changing values of model input parameters in an attempt to match field conditions within some acceptable criteria (Anderson and Woessner, 1992). Sensitivity analysis is useful in determining which parameter or parameters most influence the model results. These parameters will be emphasized in the future data collection attempting to improve model accuracy.



## CHAPTER 3

# General description of the study area

---

### 3.1. Location

The studied area is found in the North Wollo administration zone of Amhara National Regional state of Ethiopia. It has a geographical zone of  $11^{\circ}56'$  to  $120^{\circ}18'N$  and  $39^{\circ}23'$  to  $39^{\circ}47'E$ . The kobo valley is one part of the Kobo Girana Valley Development Project. The valley is surrounded by western high lands in the West, Zoble Mountain in the East, Raya valley in the North and Volcanic ridges in the South. The plain area is known by flat topography up to 1500m altitude and the mountain rises dramatically from 1500m to greater than 3000m.

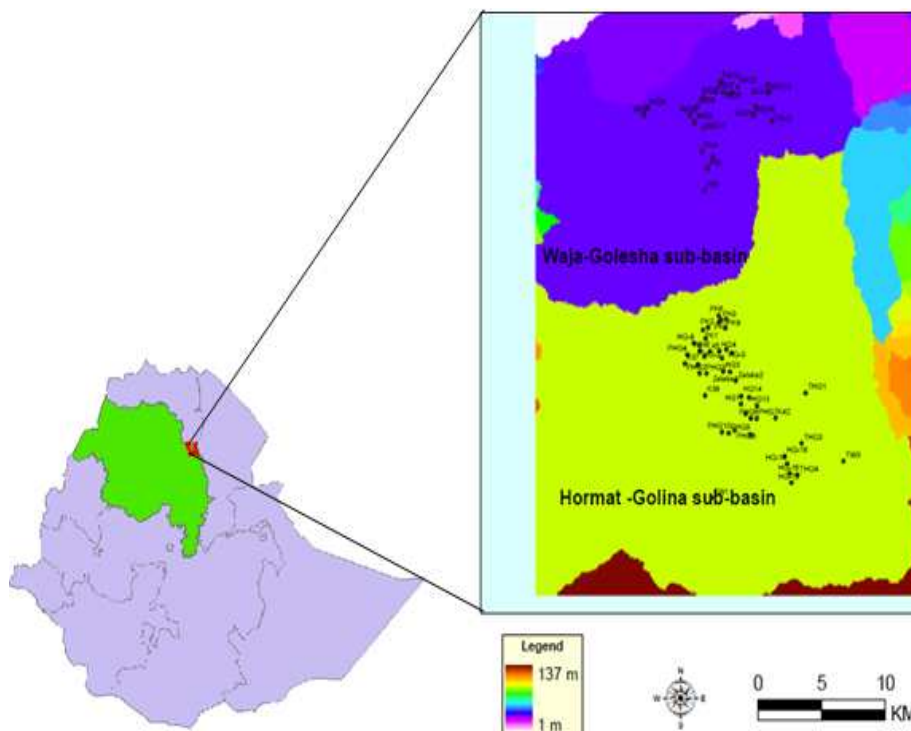

Figure 3.1 Location map of the study area.

## 3.2. Drainage

The major drainage system is associated with valley plains. The rivers in the valley originate from the western mountains. Golina, Hormat, Kelkelit and Dikala Rivers drain in to the valley. The valley can be classified in to three major sub-basins namely, Waja-Golesha, Hormat- Golina and Kobo-Areqaite-Gerbi sub -basins.

The Waja-Golesha sub-basin is drained by Gobu and Waja streams which disappear in Waja plain. There is one intermittent stream named Dikala stream which starts from the western ridge of Kobo Town and flows towards the Garalencha Mendefera before it disappears in the Chobe-Golesha plain.

The Hormat-Golina sub-basin constitutes the drainage systems of Hormat, Golina, and Kelkelit. Most of the flows of the rivers of this sub-basin too are lost in the plain before reaching their outlets through Golina River. Hormat, Golina and Kelkeli are perennial rivers in general. However, during dry season, Hormat and Kelkeli lose their discharge in the plain before joining Golina that ultimately discharge through the Golina gorge to the Afar Depression.

The kobo-Areqaite-Gerbi sub-basin is a closed sub-basin that some intermittent streams are flowing from Zobul ridge, Gedemyu and Mendefra hills into the Areqaite-Gerbi plain-depression. No surface drainage out let is observable from this depression. Wet Season Lake at Gerbi disappears in the dry season by evaporation.

There is high drainage density in the western highlands and, low both in the valley floor and eastern highlands. All rivers and streams carry large volumes of sediments from the mountains in the rainy seasons and deposit on the valley plain.

## 3.3. Climate

The main feature of rainfall in the area is seasonal, poor distribution and variable from year to year. Rainfall distribution over the valley is bimodal, followed by the long and short rainy season that occurs in July-October and February -April respectively. The rest of the months are generally dry. The mean monthly temperatures in kobo valley vary from in 12°C in December to about 35°C in June. This is shown in Appendix A, **Table A.6** and **Table A.9**. The studied area also has a monthly maximum and minimum sunshine of 9 hour in November and 5 hour in July respectively.

## 3.4. Land use and cover

Land use is essential in the hydrological and groundwater studies since it is a prominent factor influencing the recharge. From field observation and Arial photos, the land use was identified as agricultural area, woodland, forest, and bare land. The first two were the dominant land uses.

## 3.5. Geology and Hydrogeology

### 3.5.1. Geology

The geology of north and central Ethiopia, which also includes the current study area, is dominated by Tertiary volcanic strata underlain by Mesozoic sedimentary rocks. The dominant outcrops on the mountains are fissured basalts with silica varieties. The first geologist in Ethiopia, Branford, 1869 classified the northern Ethiopia volcanic into Ashange and Magdala group. Two Volcanic successions occurred in the period of Palaeocene to Miocene, recognized as the Ashangi and Magdala groups. (KGVDP).

The geological structure of the area is controlled by tectonic events that led to the development of the Rift System. These events are characterized by tensional movements which gave rise to fissure volcanism followed by block-faulting and tilting to form the escarpment zone including marginal grabens. These

marginal grabens are narrow elongated depressions bounded on both sides by normal faults facing each other. The eastern and western ridges of the Waja Golesha and Hormat Golina bounding the plain area are characterized by a system of opposite dipping faults oriented parallel to the plateau escarpments. The Waja-Golesha-Hormat-Golina plain in the study area has a length of about 33 kilometres and a width of about 10 to 17 kilometres. The widest basin in the study area reaches to 17 km at Waja-Adis Kigny and the narrowest corridor is about 10 km at Kobo-Gerbi stretch. The eastern margin of this graben is a steep slope fault downthrown to the west about 800 meters as measured from the foot of the hill to the top on the road Kobo-Zobul all weather roads (Co-SAERAR 1999).

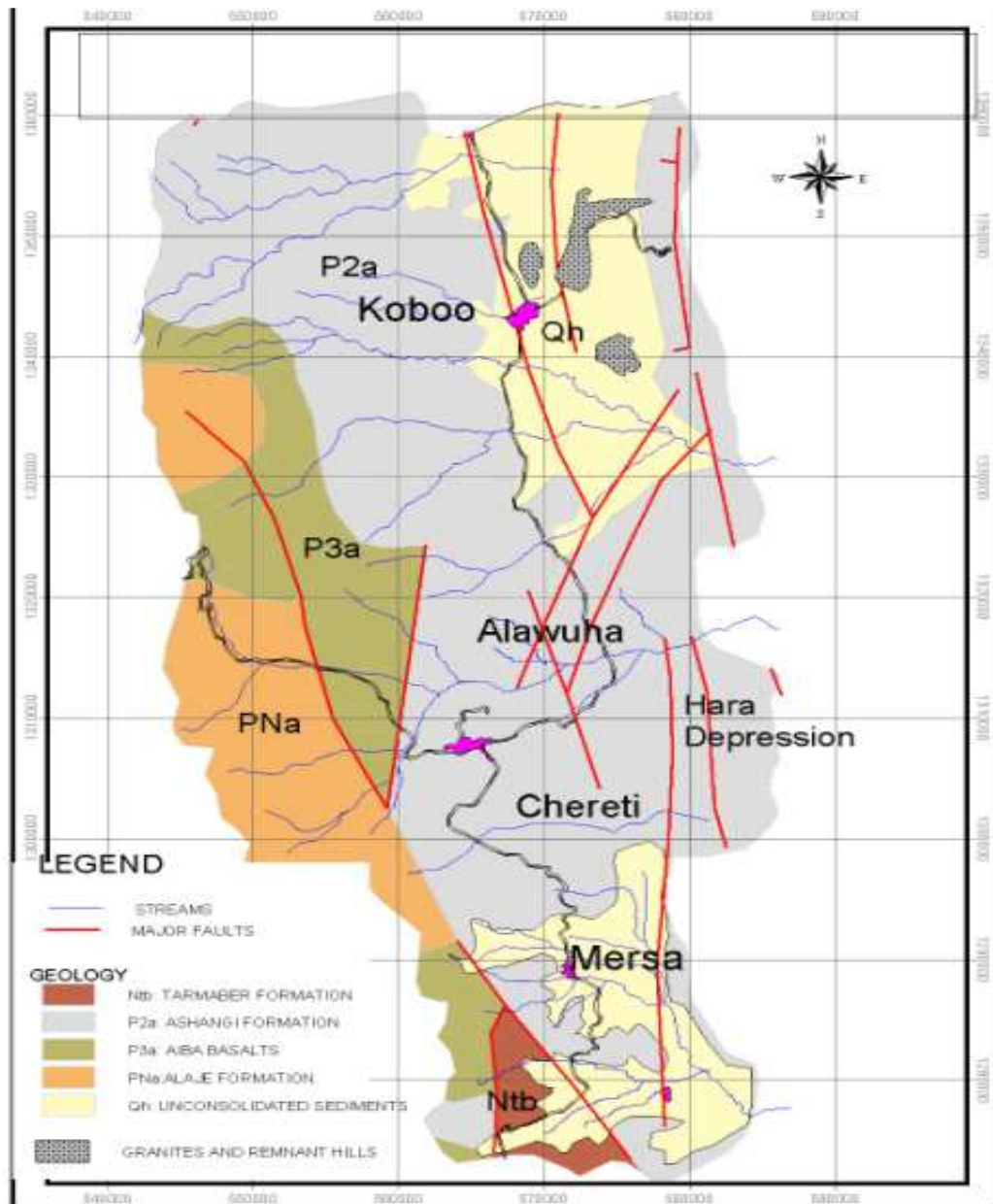

**Figure 3.2** Geology and structural map of Kobo-Girana Valley: source geological map of Ethiopia, 1996

### 3.5.2. Hydrogeology

The regional hydrogeological set up of the study area and its surrounding can be summarized as localized graben filling unconsolidated sediment composed of clay, silt, sand, gravel, boulders and pebbles above the Ashangi group volcanic which are internally underlain by Mesozoic sedimentary rocks. The Trepan volcanic and the underlying formation are strongly affected by faulting and displacements prior to the deposition of the quaternary sediments in the grabens and troughs. Regionally the Ashangi volcanic are the most extensive formations above the sedimentary basin.

With regards to groundwater movement and storage, the unconsolidated sediments in the grabens and the sedimentary rock beneath the Ashangi Group volcanic have high potential. Although localized in occurrence, the unconsolidated sediments are relatively thick with good hydraulic permeability and these sediments get recharge from the weathered part of Ashangi volcanic surrounding the grabens. The thickness of the sediment deposit increases as one moves from west to east in the valley. Geological logs of the boreholes and the geophysical surveying results show that the thickness of the sediments of the sub-basins vary from about 300 m in the east to less than 50 m near the mountains to the west. The lateral and vertical variations in grain composition of the sediment are common everywhere in the valley attributed to mixing of the proximal and distal deposits following flood and depositional cycles. As a result, the unconsolidated sediment has heterogeneous aquifer both vertically and horizontally.

Therefore, the unconsolidated sediment is recharged mainly as subsurface inflow from the locally weathered and fractured zone of the volcanic rock of the mountains surrounding the plain area. Major groundwater outflow is at the Selenwuha and Golina streams outflow to Danakil Depression and Mile-Awash, respectively, in Afar Region. The outlets have perennial flows from groundwater discharge.

## CHAPTER 4

# Analysis and Model input data preparation

---

### 4.1. Meteorological data Analysis

#### 4.1.1. Rainfall

Rainfall records of five stations were selected to describe the rainfall regime of the studied valley. Lalibela station is located near on the western high lands part of the kobo valley and the other stations are aligned linearly in North-South direction of the studied area. All stations are located outside the study area except kobo station. Fifteen year rainfall records (1996 -2010) were collected for the analysis purpose of this study in order to have adequate data (**Table A.1**). The average of monthly rainfall data of these fifteen years was taken for analysis (**Table 4.1**). The mean annual precipitation has a bimodal distribution with most of the rainfall occurring during the months July to September while there is a short rainy season from March to April. The other months are generally dry (**Figure 4.1**).Lalibela and Korem stations have a maximum mean monthly rainfall of 277mm in July and 290mm in August respectively. Similarly, a maximum value of mean annual rainfall of 968mm and a minimum value of 674mm were recorded at Korem and Kobo stations respectively.

Kobo annual rainfall distribution for 15 year showed that there is minimum rainfall of about 200mm in 2001 (see **Figure 4.3**).This was the turning point for the government officials to develop intensively Kobo Girana Valley Development Project since the farmers fail to grow crops at that year. The maximum rainfall about 1216mm was recorded in 2002 especially in the month of March and April for a value of about 499mm and 494mm respectively.

Since Kobo, Alamata and Zoble stations are closely located on the floor of Raya-Kobo valley, arithmetic mean method was used to determine the areal depth of precipitation for the study area. The weighted mean of the precipitation was calculated using equation 4.1 which is resulted in 759 mm of mean annual rainfall for the kobo valley (**Table 4.1**).

$$P_A = \frac{\sum_{i=1}^n p_i}{n} \quad (4.1)$$

$P_A$  =Mean annual rainfall for the kobo valley (mm)

$p_i$ = Measured precipitation at a given station and time (mm)

$n$ = Number of rain gauges

**Table 4.1** Mean monthly rainfall distribution mm (1996-2010)

station	Jan	Feb	Mar	Apr	May	Jun	Jul	Aug	Sep	Oct	Nov	Dec	Annual
Alamata	36.95	19.60	67.76	80.07	34.64	11.75	154.74	223.77	46.18	23.30	28.90	21.11	760
kobo	12.91	10.51	60.09	86.49	30.91	9.92	150.58	184.22	38.45	29.63	28.01	18.07	674
Korem	30.38	14.02	62.68	86.25	65.53	25.19	233.35	284.03	74.82	57.58	49.05	23.28	968
Zoble	37.60	12.47	47.00	76.61	51.65	19.55	192.74	269.23	85.87	56.59	46.76	9.56	842
Lalibela	8.60	10.11	44.01	47.75	25.16	50.92	278.16	251.57	51.30	16.51	13.96	4.44	798

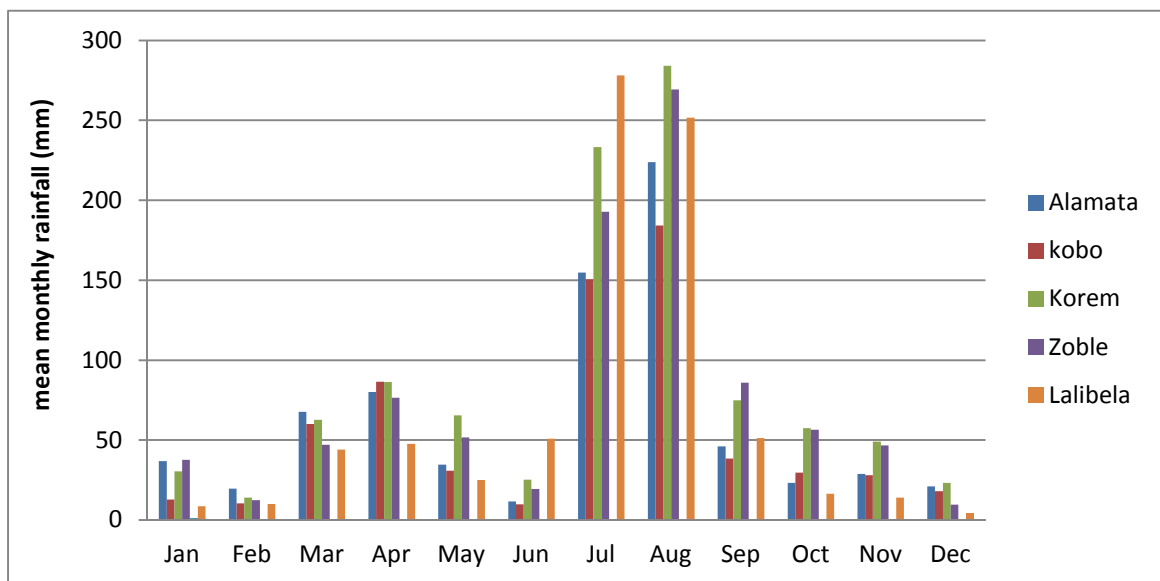

**Figure 4.1** Mean monthly rainfall of the stations (1996- 2010)

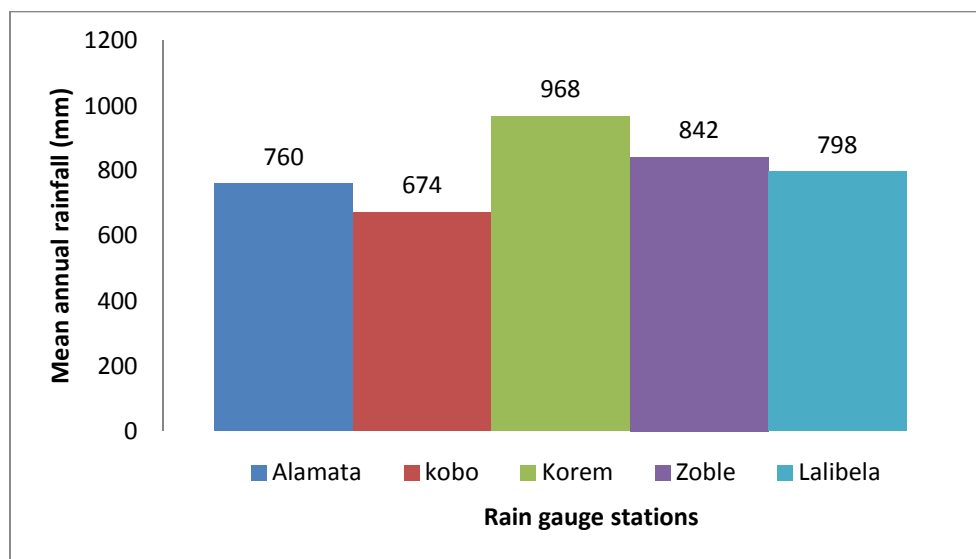

**Figure 4.2** Mean annual rainfalls of the stations

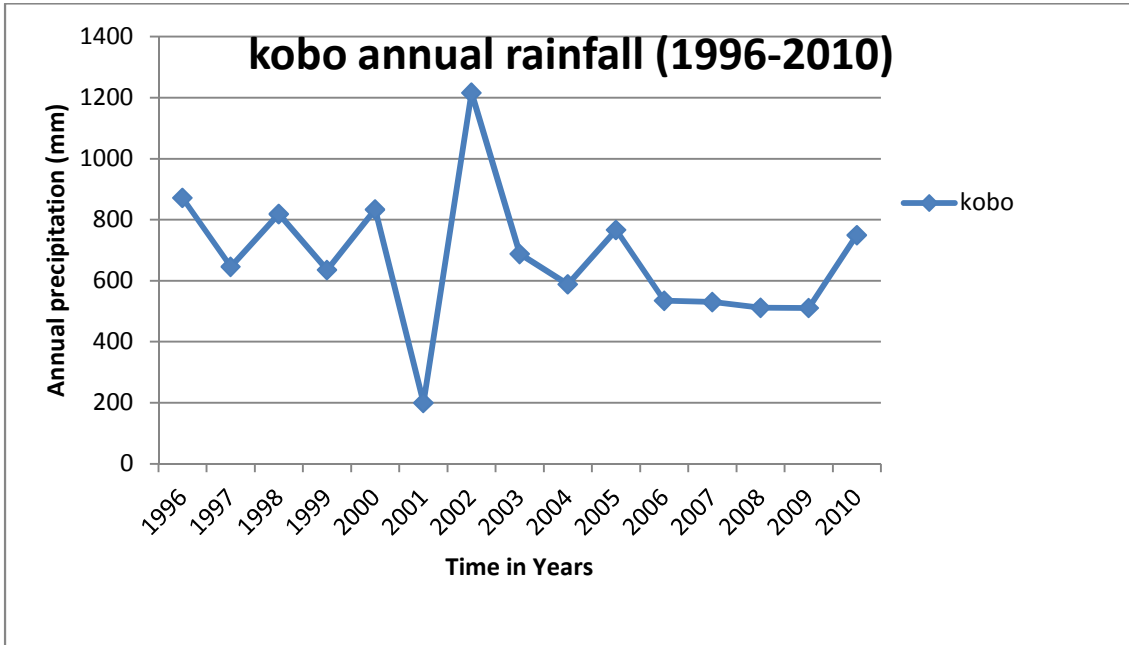

**Figure 4.3** Kobo station annual rainfall (1996-2010)

#### 4.1.2. Temperature

To analyse the climatic variation in the high land and low land areas of the kobo valley, Korem and Kobo stations were selected respectively. As illustrated in the **Figure 4.4**, average monthly maximum temperature of 26°C and 35°C were recorded both in June at Korem and Kobo station respectively. On the other hand, the average monthly maximum temperature of both station show lowest record in January. The stations have about 9°C in their maximum temperature. The maximum temperature in Korem ranges from 20°C to 26°C and in Kobo from 27°C to 35°C. The detailed record is presented in **Table A.6** and **Table A.8**.

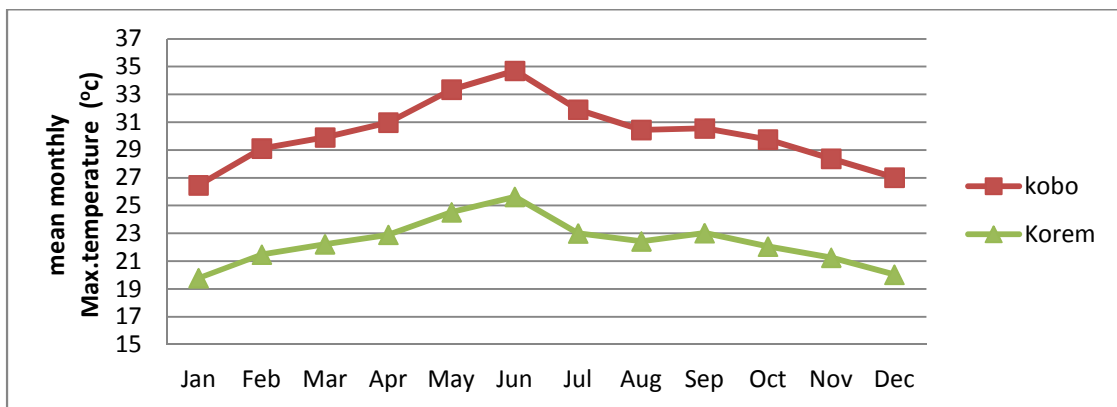

**Figure 4.4** Mean Monthly Maximum Temperatures of Kobo & Korem Station

Even though, the two stations have significant difference in climatic variation, the general trend of average minimum temperature variation of both stations is similar as seen in **Figure 4.5**. However, the average minimum temperature shows lowest value of about 11°C and 4°C in the month of December for both stations and highest values of about 19°C in June for Kobo and 12°C in the month of July for Korem stations. See the record in Appendix A, **Table A.9** and **Table A.11**.

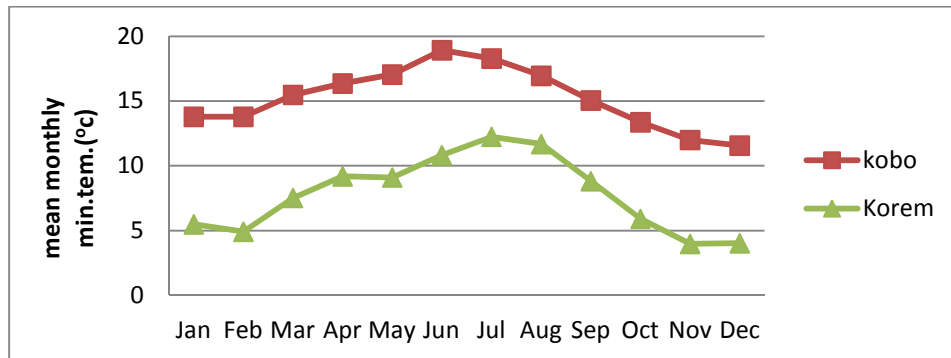

Figure 4.5 Mean monthly minimum temperature (°C) of Kobo and Korem

#### 4.1.3. Wind speed

Wind direction refers to the direction from which the wind is blowing. It is expressed by its direction and velocity. Wind speed is the relevant variable in order to compute evapotranspiration. The mean monthly value show lowest record of 1.01m/s in September and highest record of 2.02 m/s in March. See the record in Appendix A, Table A.12.

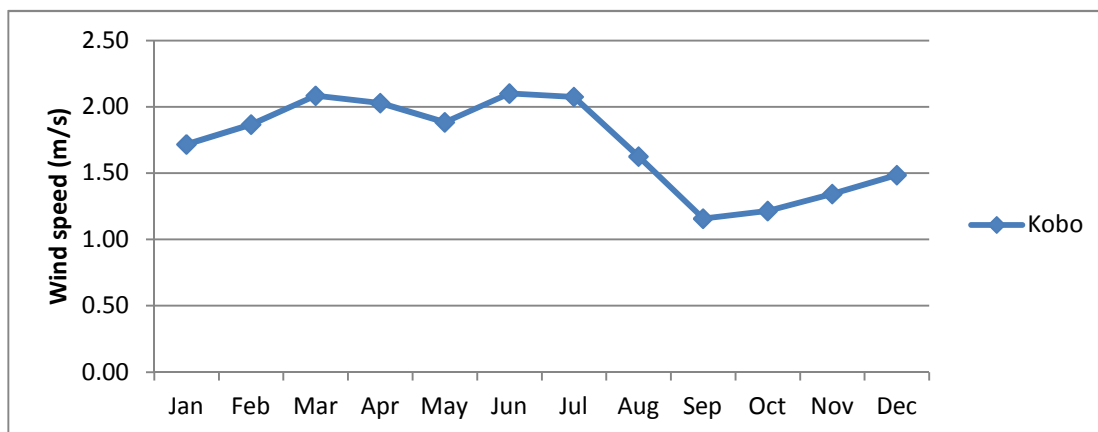

Figure 4.6 Mean monthly Wind speed of kobo

#### 4.1.4. Solar Radiation

Solar radiation changes large quantities of liquid water into water vapour through the process of evaporation. Consequently, the evapotranspiration process is determined by the amount of energy available to vaporize water. Mean sunshine hour for Kobo station is above 8 hours from March to May and October to December. Minimum sunshine hour was recorded in July about 5 hours. See the other record in Appendix A, Table A.13.

#### 4.1.5. Evapotranspiration (ET<sub>o</sub>)

Evapotranspiration is the process in which water is returned back to the atmosphere by a combination of evaporation and transpiration. Potential evapotranspiration is the water loss that will occur under given climatic condition without deficiency of water supply whereas actual evapotranspiration is the amount of water that actually returns to the atmosphere depending on the availability of water. For this study, Penman-Monteith equation is used to estimate potential evapotranspiration from gathered weather data. It is one of the best methods since it integrates the effect of factors such as altitude, aerodynamics, geographic location, and solar radiation for computation. For this computation, 15 year (1996-2010) meteorological data were used as an input for the ET<sub>o</sub> calculator Programme. The programme is developed by FAO (Food and Agriculture Organization of the United Nations).



The estimated annual  $ET_0$  for Kobo station as 1799mm as observed in **Table 4.2**. It is calculated based on the Penman-Monteith method. This value is by far larger than the annual precipitation which was recorded as 674mm. The monthly  $ET_0$  at Kobo ranges from 128mm in January to 180mm in May (See **Figure 4.7**).

**Table 4.2** Computed  $ET_0$  of Kobo station using Penman-Monteith equation.

Month	Tmax( $^{\circ}$ C)	T min( $^{\circ}$ C)	sunshine (hour/day)	$E_{t0}$ (mm/day)	$E_{t0}$ (mm/month)
<b>Jan</b>	26.78	12.66	7.77	4.13	128.13
<b>Feb</b>	29.01	13.05	7.81	4.75	132.91
<b>Mar</b>	29.79	14.52	8.45	5.21	161.41
<b>Apr</b>	30.92	15.59	8.48	5.48	164.40
<b>May</b>	33.15	16.43	8.75	5.81	180.01
<b>Jun</b>	34.01	17.99	6.51	5.34	160.20
<b>Jul</b>	31.59	17.90	5.15	4.75	147.15
<b>Aug</b>	30.46	16.89	5.88	4.81	149.01
<b>Sep</b>	30.51	15.04	6.77	5.01	150.20
<b>Oct</b>	29.79	13.56	8.35	4.99	154.59
<b>Nov</b>	28.79	12.46	9.36	4.69	140.80
<b>Dec</b>	27.21	12.02	8.59	4.21	130.61
<b>Average</b>	<b>30</b>	<b>15</b>	<b>8</b>	<b>5</b>	<b>1799</b>

Perman-Montheith equation was used in to  $ET_0$  Calculations with the values for Angstrom's Coefficients:  $a = 0.25$  and  $b = 0.5$ .

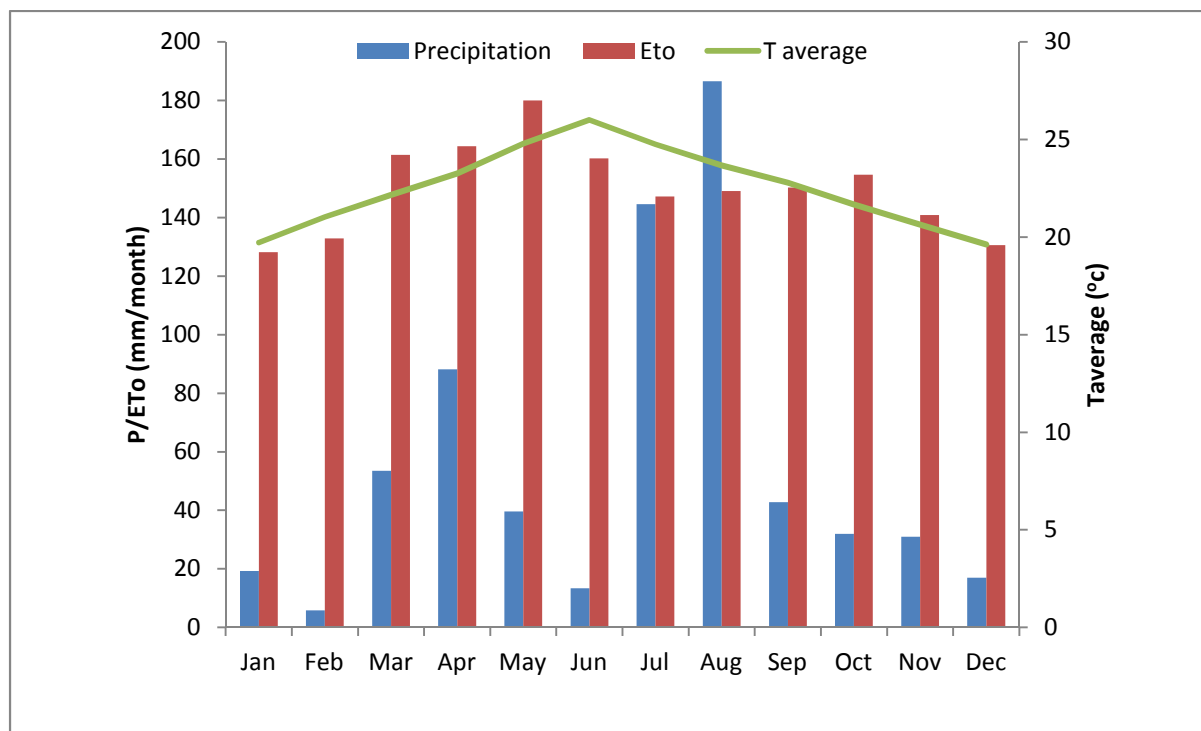

**Figure 4.7** Precipitation (P), potential evapotranspiration ( $ET_0$ ) and average monthly Temperature ( $T_{avg}$ ) for Kobo station (1996 to 2010)

## Actual evapotranspiration

Actual evapotranspiration is the amount of water that actually returns to the atmosphere depending on the availability of water.

The Turc, Langbein and Wundit empirical formula was used to estimate the mean areal actual evapotranspiration of the valley of the studied basin. A widely used formula to estimate annual values of ETa for catchment areas and it represents all the different climates including Africa (Shaw, 1994). The formula takes into consideration mean annual precipitation and mean annual temperature of the catchment area. Turc showed that the formula could be applied in humid and arid climates, either hot or cold (Shaw, 1994).

$$E = \frac{P}{\sqrt{0.9 + \frac{(P)^2}{[L(t)]^2}}} \quad 4.2$$

Where,

E: mean annual evapotranspiration (mm)

P: mean annual precipitation (mm)

t: mean annual temperature (°c)

$$L(t) = 300 + 25t + 0.05t^3$$

The mean annual actual evapotranspiration of the kobo valley was calculated as 704mm according to equation 4.2.

## 4.2. Groundwater recharge estimation

### 4.2.1. Water Balance Method

Groundwater recharge is defined as the entry into the saturated zone of water made available at the water table surface together with the associated flow away from the water table within the saturated zone (Freeze & Cherry, 1979). Quantifying the rate of recharge to aquifer is the most difficult of all measures in the evaluation of groundwater resources. Estimation of groundwater recharge requires modelling of the interaction between all the important processes in the hydrological cycle such as precipitation, infiltration, surface runoff, evapotranspiration, soil moisture and groundwater level variations (Jyrkama and Sykes, 2007).

Meteorological data limitation together with absence of hydrological data within this basin made the estimation of groundwater recharge very tough. In this study, recharge was estimated using water balance method.

Thus, the groundwater recharge for the valley area can be calculated using simple water balance method;

$$R = P - ETa + Sr - S \quad 4.3$$

Where, P: Annual precipitation (mm)

ETa: Annual Actual evapotranspiration (mm)

Sr: Annual Surface runoff (mm)

R: Recharge to groundwater (mm /year)

S: Soil moisture content (mm)

The valley floor including its escarpment receives relatively low annual precipitation (759mm) and has annual actual evapotranspiration (704mm). Recharge in this area is generally assumed to be very minimum from direct precipitation. However, the valley floor gets recharge from runoff along escarpments and stream leakage which flow down the highlands. The runoff from the highland area flow out to the valley floor along two mainstream channels, Golina and Hormate streams, and few along Keleklit stream.

Thus, the amount of recharge to the valley floor can be estimated in two ways;

- ✚ The direct recharge which is surplus of evapotranspiration and soil moisture considering that insignificant runoff over the valley plain.
- ✚ The indirect recharge from runoff along the valley escarpment.

The direct recharge was calculated as 33mm/year using equation (4.2) and the soil moisture content (22mm) was adopted from Co-SAESAR (1999) which was computed from SCS model, while the indirect recharge was assumed 40% of the runoff from the valley escarpment considering the catchment characteristics of the valley and previous hydrological reports of Co-SAESAR (1999).

According to RVPD (1998), the runoff coefficient for the escarpments was estimated between 0.13 to 0.22. Assuming 15% of the precipitation as annual runoff (114mm), the indirect recharge was 46mm/year. The total recharge for the kobo valley was the sum of the direct and indirect recharge which was resulted in 79mm/year.

#### 4.2.2. Darcy Approach

This approach considers groundwater flux through a flow width perpendicular to the general gradient of groundwater flow. The annual discharge of this groundwater can be estimated using the following formula.

$$Q = 365 * T * I * B \quad 4.4$$

Where Q = discharge (m<sup>3</sup>/year)

T = Transmissivity (m<sup>2</sup>/day)

I = hydraulic gradient

B = groundwater flow channel width (m).

**Table 4.3** Darcy approach recharges estimation of Hormat-Golina and Waja-Golesha sub-basins

Sub-basin	Flow width(m)	Flow line length(m)	Difference in water table elevation along the flow line(m)	Slop of GW long the major flow line	Average Transmissivity (m <sup>2</sup> /day)	Flow in MCM
Hormat-Golena	16680	13000	155	0.0119	600	44
Waja-Golesha	13000	14000	118	0.00843	600	24
Total						68

Source: KGVDP Hydrogeology report

Another recharge source to the valley area is direct infiltration from precipitation mainly during torrential rain falls. The annual precipitation was calculated as 759mm. In this study the annual infiltration rate is taken to be about 5% (38 mm) of the precipitation based on hydrology report of Co-SAESAR (1999). The surface area of the plain area of Waja-Golesha and Hormat-Golina sub-basins is 165 and 231 km<sup>2</sup>, respectively. The plain areas of the sub-basins were delineated by using Global Mapper software. Therefore, the direct infiltration on these sub basins is estimated to be about 9 MCM for Hormat-Golina and about 6 MCM for Waja-Golesha.

In conclusion, the total recharge in Waja-Golesha (30 MCM) and Hormat-Golina (53 MCM) sub-basins of Kobo valley is estimated to amount 83 MCM.

### 4.3. Pump test data Analysis.

Pumping test is a scientific approach where the groundwater storage and movement is expressed on terms of the physical and hydraulic properties of the aquifer system. Aquifers are groundwater reservoir where the lateral continuity and vertical boundaries are often not well defined. Since direct observation of groundwater movement is impossible, mathematical analysis offers a convenient and reliable way to

predict what happens to water in the ground. It is therefore, imperative to derive simple mathematical expressions for describing the flow region of water in the subsurface. Groundwater declining due to pumping can be defined with different well flow equations which are developed for steady state and unsteady state flows for various types of aquifers and boundary conditions. Together with the basic assumptions and conditions for steady and unsteady state flows, the equations are presented in their final mathematical form for practical application.

In this study, the main objective of collecting pump test data was to determine the aquifer hydraulic parameters such as transmissivity and hydraulic conductivity, which later used as one of the model input parameters. The aquifer parameters are important as they give an understanding of the groundwater flow in the system. Kruseman and de Ridder (1992), suggested that generally all the analytical methods assumed the aquifer is homogenous and isotropic, groundwater flow is horizontal and Darcy's law is valid, discharged at constant rate, fully penetrating well of very small diameter and geologic formations are horizontal and have infinite horizontal extent. Geo Engineering Service (GES, 2003) and Metaferia Consulting Engineers (MCE, 2009) were conducted some pumping test analysis for the alluvial aquifer of the kobo valley.

The aquifers in the study area are mainly Quaternary alluvial deposits, and fractured and weathered basalts. Totally 70 boreholes were inventoried in this study and almost all were sunk in the alluvial sediments aquifer with the exception of very few boreholes which are located in the volcanic aquifer. However, most of the early constructed boreholes have incomplete data. All the boreholes were sunk in the alluvial aquifer. Among these boreholes, 10 of them have observation well (See **Table B.1**).

The pumping test data show that the constant test was conducted for 72 hours for most of the boreholes. The data obtained by measuring the drawdown at a single location outside the pumping well only permit calculation of the average permeability, transmissivity and storability (coefficient of storage) of the aquifer. The need of two or more observation wells at different distances is to analyze the time- drawdown and distance-drawdown relationships. The value of transmissivity and storage coefficient is important because they define the hydraulic characteristics of a water bearing formations. The transmissivity value indicates how much water will move through the formation and the coefficient of storage indicates how much can be removed by pumping or draining. The distance drawdown curve helps for the determination of the effect of pumping at any distance from the pumped well.

All the hydraulic parameters were taken from Kobo Girana Valley Development Project office (See **Table B.1**).

## CHAPTER 5

# Groundwater Modelling of Kobo Valley

---

### 5.1. Introduction

Gathering and assemblages of relevant hydro geological data is crucial for proper groundwater modelling. This process includes identifying hydrostratigraphic units, estimating transmissivity values, defining system boundaries, etc.

There are two areas of hydrogeology where we need to rely on models of real hydro geological system: to understand why a flow system is behaving in a particular observed manner and to predict how a flow system is behaving (Fetter, 2001). There are several ways to classify groundwater flow models, models can be either transient or steady state and one, two or three spatial dimension. Steady state flow occurs when at any point in a flow field the magnitude and direction of the flow are constant with time (Anderson and Woessner, 1992).

In order to have confidence in model simulation results, realistic model inputs and better understanding of the hydrologic system of the studied area are imperative. In this chapter, the aquifer system of kobo valley was modeled using PMWIN *Pro* (Chiang et al., 1998) as pre –and post – processor for MODFLOW (McDonald and Harbaugh, 1988) assuming steady-state condition. The aquifer was modeled under unconfined condition and confined condition represented by a two layer with varying thickness. A grid cell size of 300m x 400m was used. Model area and the elevations of the top layer were delineated by the ASTER DEM optimization and use of the topographic maps. Aquifer properties were adopted from the results of the pumping test data analysis. Recharge to the major component of the system was considered to take place as direct infiltration of precipitation for the entire model area and further inflow from the surrounding hills. Simplified water balance method and Darcy's approach were employed to estimate the recharge. Trial and error method was used to calibrate the model using the observed hydraulic head.

#### 5.1.1. The modelling Process

To ensure that the modelling study is conducted correctly, it is important to use a proper modelling methodology. This is also increase confidence in the results of the model (Anderson and Woessner, 1992). The modelling protocol suggested by Anderson and Woessner (1992) was followed to come up with good result (**Figure 5.1**).

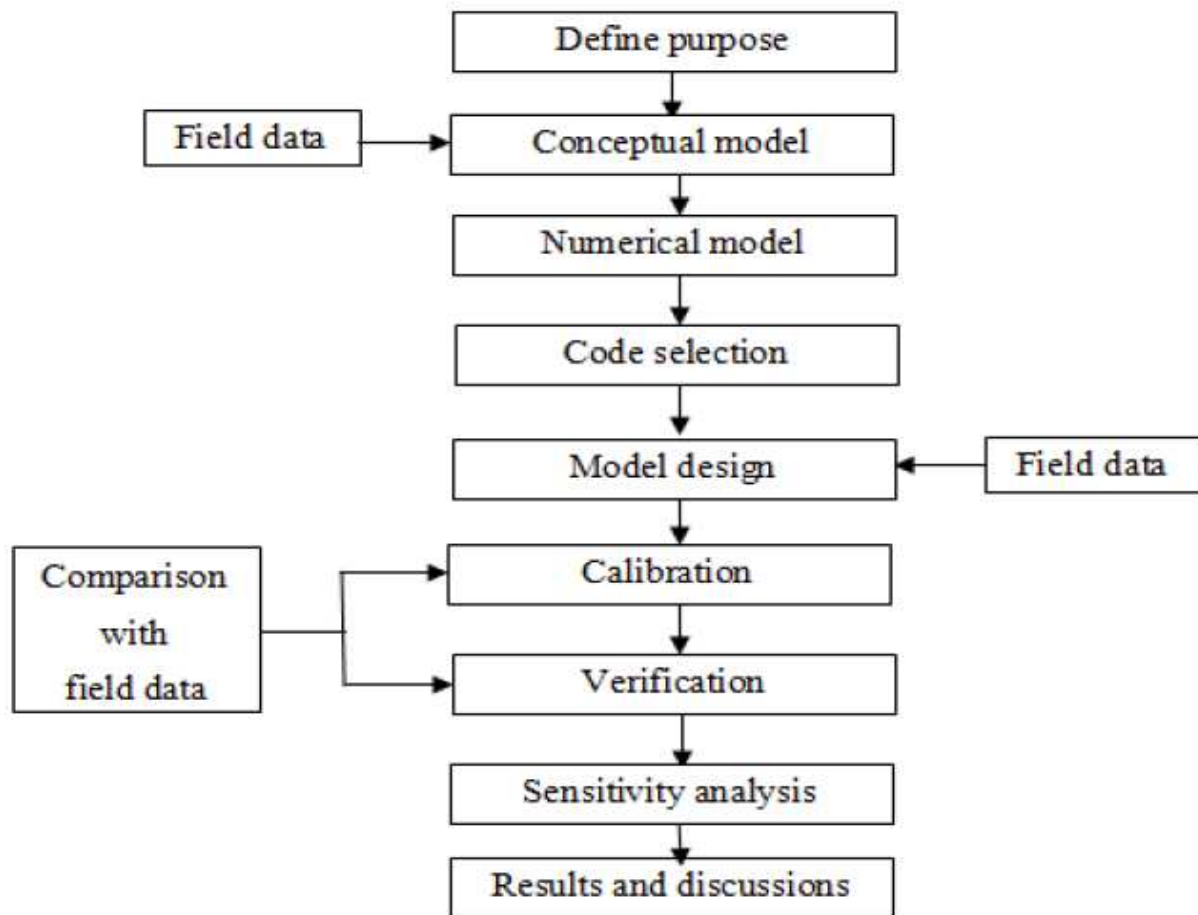

Figure 5.1 Steps in modelling protocol (after Anderson and Woessner, 1992).

## 5.2. Conceptual Model

Developing the appropriate conceptual model for a given problem is one of the most imperative steps in the modelling process. Over simplification may lead to a model that lacks the required information, while under simplification may result in the lack of data required for model calibration. A conceptual model describes how water enters an aquifer system, flows through the aquifer system and leaves the aquifer system. Briefly, it describes the hydrologic system with respect to aquifer properties, flow characteristics and boundary conditions. According to Anderson and Woessner (1992) there are three steps in building a conceptual model: defining hydrostratigraphic units, preparing a water budget and defining the flow system.

Even though, there was very limited data particularly for Waja-Golesh sub-basin; a simplified conceptual model was developed for both sub-basins for the groundwater flow system in Kobo valley. To develop the conceptual model, some simplifying assumptions were made. The assumptions include: the model consists of two layers, the model is two dimensional, the aquifer is unconfined and confined with varying thickness and, the groundwater flow is horizontal.

In principle the groundwater flow and contaminant transport in porous medium domain are three-dimensional. However, when considering regional problems, one should note that because of the ratio of aquifer thickness to horizontal length, the flow in the aquifer is practically horizontal. The horizontal dimension may be from tens to hundreds of kilometers with a thickness of tens to hundreds of meters (Bear, 1979).

Simplification is important because complete reconstruction of the filed system is not feasible. The conceptual model should be simplified as much as possible while it is still remains complex enough to represent the system behavior (Anderson and Woessner, 1992). In this study, to simplify the complex nature of the two sub-basins, a simplified conceptual hydro geological model of the groundwater system was developed based on information about geology, hydrogeology and hydrology.

The system is considered in a steady- state throughout the year for the modeling purpose. The simplified conceptual groundwater system of the two-basins is shown in **Figure 5.2**.

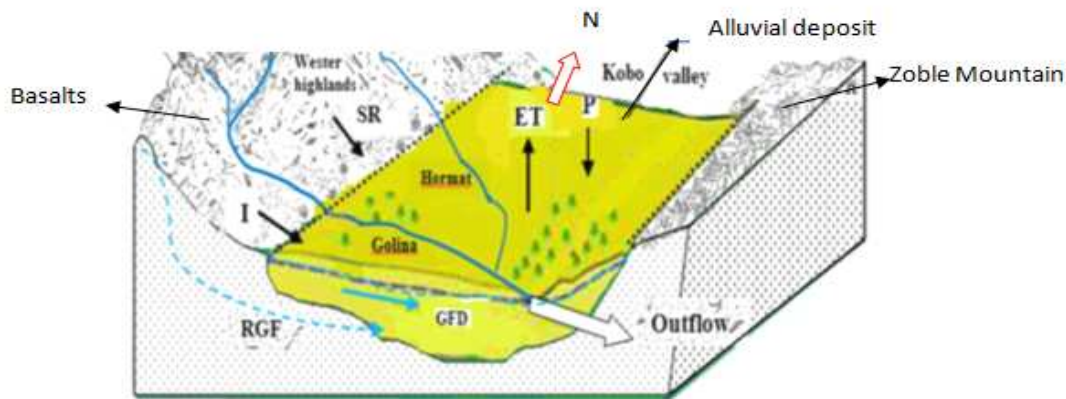

**Figure 5.2** Schematic diagram illustrating the simplified conceptual model. P = Precipitation, ET = Evapotranspiration, I = Infiltration, SR = Surface runoff without defined channel, RGF = Regional groundwater flow path, GFD = Groundwater flow direction

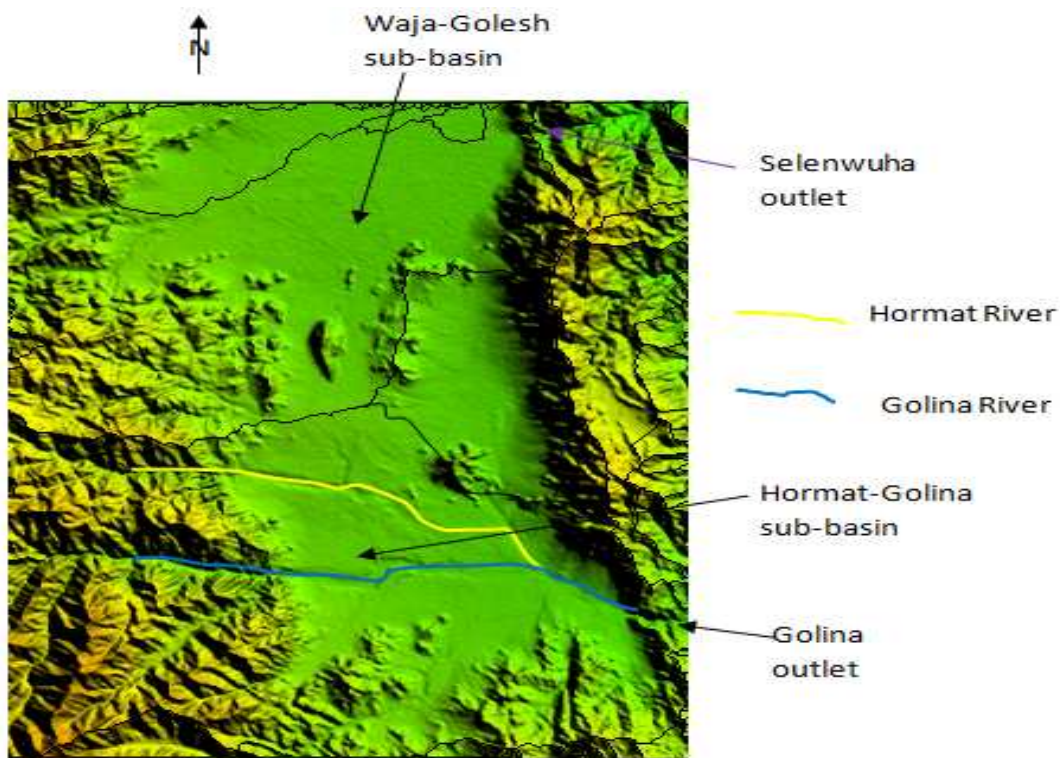

**Figure 5.3** Simplified Conceptual model as taken from Global Mapper.

### 5.2.1. Boundary Conditions

Boundary conditions are constraints imposed on the model grid that express the nature of the physical boundaries of the aquifer being modelled. Boundary conditions have great influence on the computations of heads within the model area. Anderson and Woessner (1992) defined three types of mathematical conditions used to represent hydro geological boundaries:

- ❖ Specified head boundaries (Dirichlet conditions)
- ❖ Specified flow boundaries (Neuman conditions)
- ❖ Head-dependent flow boundaries (Cauchy or mixed conditions)

Boundary conditions are mathematical statements specifying the dependent variable (head) or the derivative of the dependent variable (flux) at the boundaries of the problem domain. In steady-state simulation, the boundaries largely determine the flow pattern. Therefore, correct selection of boundary conditions is a critical step in model design (Anderson and Woessner, 1992).

The lateral boundaries of the model area are: either no-flow or head dependent flux boundaries. Even though water may enter in to the alluvial sediment from the surrounding mountainous areas at the contact, no-flow boundaries are assigned to the model at these areas except for the fractured zones and stream bed boundaries, assuming that minimum or no groundwater enter in to the modelled area from the ridges. The location of head-dependent flux boundary for the study area is assumed at the localities of the fracture zones of the surrounding ridges along valley channels and gullies. Topographically low areas along which surface water and groundwater outflow are also considered as the head dependent flux boundary and the model is simulated with the General-Head-Boundary (GHB) module of the MODFLOW at these localities. Similar boundary conditions are considered for both layers of the model.

The top boundary of the model, the upper boundary of layer-1, was simulated as a free surface boundary, which include specified-flux and head-dependent flux boundary cells. The specified-flux boundary is the areally applied groundwater recharge and the head-dependent boundary represents springs and groundwater seeps from river beds. Recharge was specified and simulated with the recharge (RCH) module; Golina River was simulated with river (River) module. The bottom boundary of the model is a specified no-flow boundary. This no-flow boundary is located where the aquifer comes in to contact with massive bedrock.

### 5.2.2. Stratigraphic Units

Identification of hydrostratigraphic units is crucial in determining the number of layers controlling groundwater flow within the system. A hydrostratigraphic unit is comprised of geological units of similar hydro geological properties. Numerous geological units may be grouped together or a single formation may be subdivided into different aquifers and aquitards (Anderson and Woessner, 1992).

Layer-1 correspond the entire alluvial sediments which range in thickness from around 50m near the divide of the two sub-basins near Kobo area to 270m at Central Golesha and 246m at the area downstream of Abuare and Gedemeyu Villages where clay and silt are predominant. The weathered bedrock underlying the alluvial sediment of the area is taken as Layer-2 of the model which has an average thickness of 40m. (See Figure 5.6)

### 5.2.3. Sources and sinks of the Model area

The main groundwater source for this studied valley is direct recharge from precipitation that fall at the highlands and the valley floor. However, the valley floor gets additional recharge from surface runoff along the escarpments and from stream leakages that drain the highlands. The primary output or sink is groundwater outflow in the form of base flow at Golina outlet and Selenwuha outlet for Hormat-Golina and Waja-Golesha sub-basin respectively (See Figure 5.3).

#### Recharge

Groundwater recharge was estimated using water balance method and Darcy's approach which is discussed in section 4.2. As observed from field visit, there are no recharging wells in the study area. The recharge from excess irrigation is assumed to be negligible.



## Groundwater outflow/sinks

The ways of groundwater discharge from the aquifer system is mainly by discharge to streams. The main stream (Golina) that drains the western highlands gets its base flow from the volcanic aquifer and losses some amount when it reaches the valley floor (the alluvial deposits). However, near the outlet to Afar it gains some amount as it was evidenced from increased flow during field visit. On the other hand, the Hormat stream collects some seepage flows from the western highlands and loses into the alluvial sediments along the stream course (See **Figure 5.4**).



**Figure 5.4** Golina river near the outlet to Afar.

Evapotranspiration from the groundwater system can be assumed to be negligible, since there are no significant groundwater discharge areas such as marshes, swamps, and/or lakes within the basin.

The river package is designed to simulate the effect of flow between rivers and aquifers based on the following relations:

$$QRIV = CRIV (HRIV - h) \quad \text{For } h > RBOT \quad 5.1$$

$$QRIV = CRIV (HRIV - RBOT) \quad \text{For } h \leq RBOT \quad 5.2$$

$$CRIV = \frac{KLW}{M} \quad 5.3$$

Where:

QRIV = rate of leakage between the river and aquifer [ $L^3T^{-1}$ ]

CRIV = hydraulic conductance of the river bed [ $L^2T^{-1}$ ]

HRIV = head in the river [L]

h = hydraulic head in cell [L]

RBOT = elevation of the bottom of the riverbed [L]

K = hydraulic conductivity of the riverbed material [ $LT^{-1}$ ]

L = length of the river within a cell [L]

W = width of the river [L]

M = thickness of the riverbed [L]

Data were taken for the river conductance calculation along the longitudinal of the Golina and Hormat rivers. The hydraulic conductivity was also adopted from literature.

Groundwater has been abstracted for irrigation and water supply purposes. However, there is no recorded data regarding the abstraction rate and duration of pumping from the wells. According to the information from KGVDP office, Kobo town water supply office and operators, the amount of water abstracted from the wells was estimated to be  $5 \text{ Mm}^3\text{y}^{-1}$  (see **Table 5.1**).

**Table 5.1** The estimated amount of water abstracted from boreholes per annual

Irrigation boreholes (water used per crop season)									
Well ID	Discharge (l/s)	Jan (24*6hrs)	Feb (24*12hrs)	Mar (24*16hrs)	Apr (24*16hrs)	May (24*14hrs)	Jun (24*12hrs)	m3/annual	m3/day
HG1	51	26438	52877	70502	70502	61690	52877	334886	917
HG2	51	26438	52877	70502	70502	61690	52877	334886	917
HG6	50	25920	51840	69120	69120	60480	51840	328320	900
HG7	50	25920	51840	69120	69120	60480	51840	328320	900
HG8	50	25920	51840	69120	69120	60480	51840	328320	900
HG9	10	5184	10368	13824	13824	12096	10368	65664	180
Hg10	34	17626	35251	47002	47002	41126	35251	223258	612
TW1	7	3629	7258	9677	9677	8467	7258	45965	126
Zelege1	50	25920	51840	69120	69120	60480	51840	328320	900
Zelege2	50	25920	51840	69120	69120	60480	51840	328320	900
WG1	51	26438	52877	70502	70502	61690	52877	334886	917
WG2	40	20736	41472	55296	55296	48384	41472	262656	720
WG4	52	26957	53914	71885	71885	62899	53914	341453	935
WG5	52	26957	53914	71885	71885	62899	53914	341453	935
WG14	25	12960	25920	34560	34560	30240	25920	164160	450
Kobo town water supply bore holes									
K1	10	10 x 8hrs x365d						105120	288
K5	38	38 x 8hrs x365d						399456	1094
K6	38	38 x 8hrs x365d						399456	1094
Kobo Rural Water Supply bore holes									
K37	2.5	2.5 x 8hrs x365d						26280	72
K38	4.2	4.2 x 8hrs x365d						44150	121
K42	4.5	4.5x 8hrs x365d						47304	130

d = average pumping days per month, hrs = pumping hours per day

#### 5.2.4. The Model area

The modelled area is 30 by 40 km from UTM 555000m to 585000m and 1323000m to 1363000m Easting and Northing respectively. It contains the entire two sub-basins, Hormat-Golina and Waja-Golesha, located in the South and North respectively ( Figure 5.5). The model uses a grid size of 300m by 400m and contains: two layers, 100 columns, 100 rows and 10,000 cells in each layer originally. After refining the grid sizes around the main aquifer areas, it was split in to 148 columns and 145 rows and 21,460 cells in each layer. The irregular shape and the locally bounded nature of the aquifers of the study area reduced the number of active cells in the model. Even though the whole catchments of the two sub-basins of Hormat-Golina and Waja-Golesha is wider, it is only the alluvial plain and underlying weathered bedrock modelled numerically so that the modelled area is narrower than the entire catchments area for the sub-basins ( Figure 5.5).

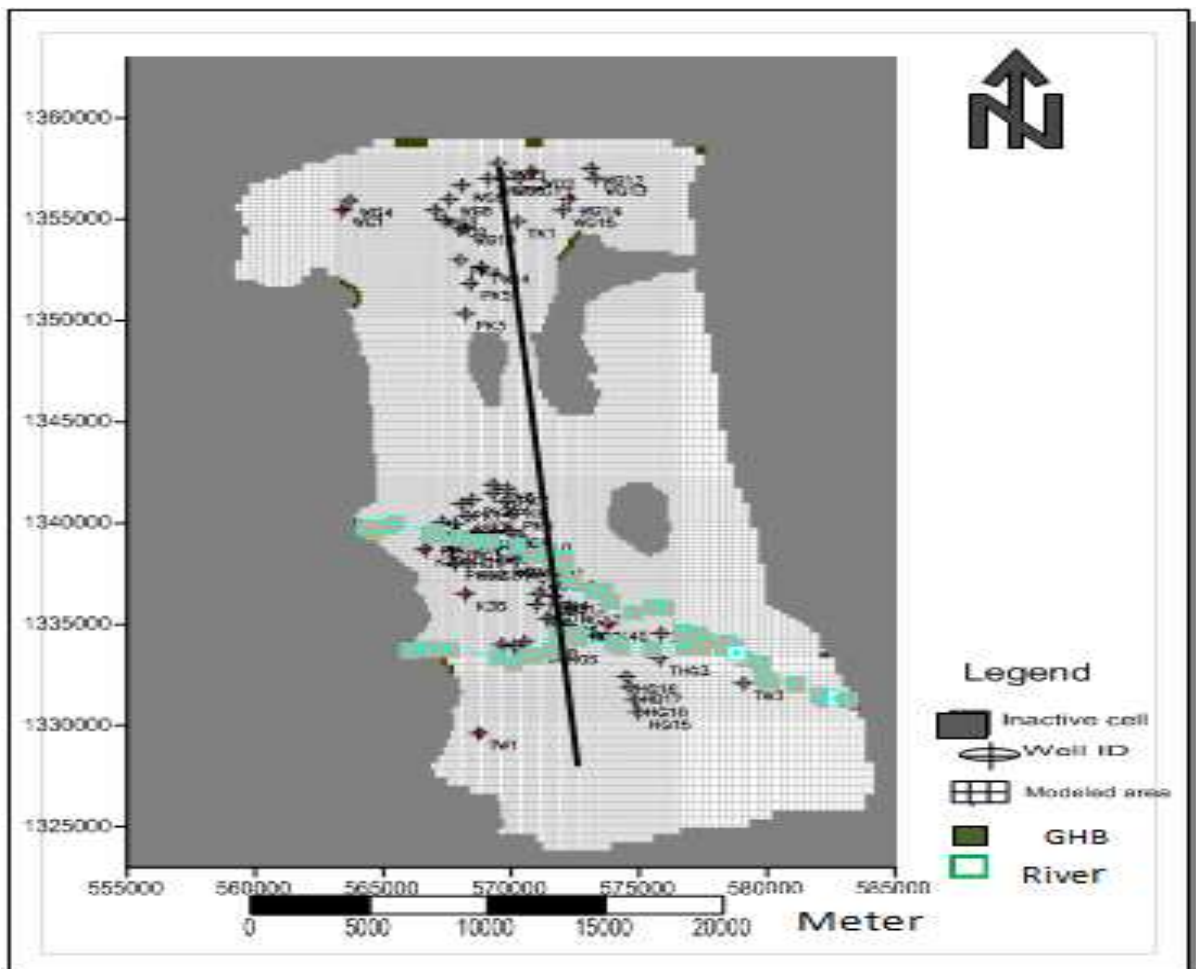

Figure 5.5 Plan View of the Entire Modelled Area

#### 5.2.5. Aquifer Geometry

The aquifer was discretized vertically in to two layers (layer-1 and layer-2, Figure 5.6). Layer-1 correspond the entire alluvial sediments which range in thickness from around 50m near the divide of the two sub-basins near Kobo area to 270m at Central Golesha and 246m at the area downstream of Abuare and Gedemeyu Villages where clay and silt are predominant. The weathered bedrock underlying the alluvial sediment of the area is taken as Layer-2 of the model which has an average thickness of 40m.

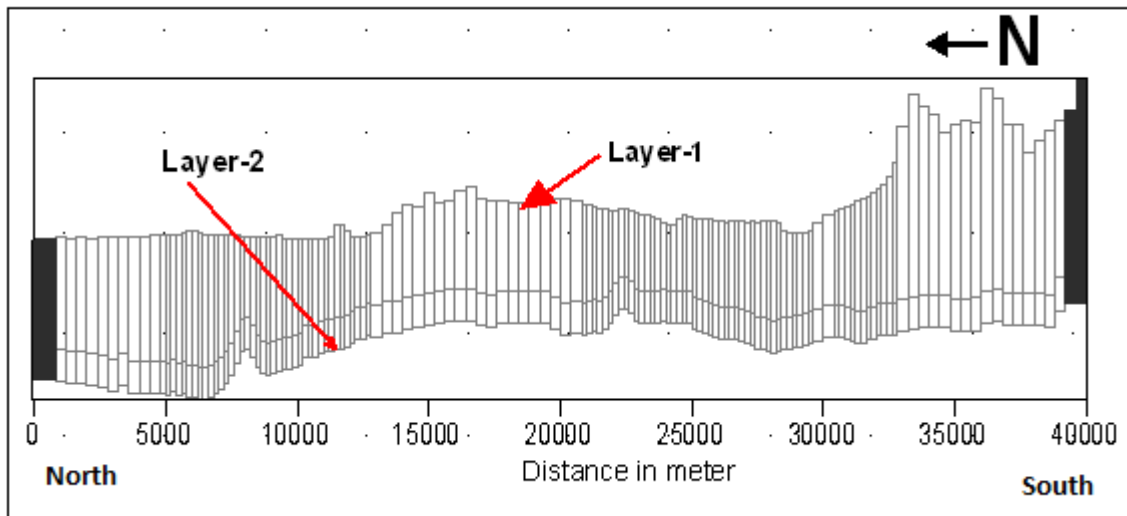

Figure 5.6 Cross-Sectional View of the Model Area along Line North to South of Fig. 5-5

### 5.3. Numerical Model

Numerical model development allows for a detailed analysis of the movement of water through the hydrologic units that constitute the groundwater flow system. The groundwater flow in the unconsolidated deposit of the Kobo valley was simulated using the U.S. Geological Survey modular three – dimensional finite- difference groundwater flow model, MODFLOW (McDonald and Harbaugh, 1988). This numerical modelling was performed using the interface of Processing Modflow Pro (*PMWIN Pro*), Version 8.0 (Chiang and Kinzelbach, 2001) as code environments for the data input and output management. *PMWIN Pro* supports MODFLOW- 2000, PEST- ASP, different packages, and models/programs. It is founded on the physical theory of groundwater movement: Darcy's law and the continuity equation. The steady- state groundwater flow is simulated based on the following governing differential equation under two- dimensional aerial view (Anderson and Woessner, 1992).

$$\frac{\partial}{\partial x} \left[ K_x \frac{\partial h}{\partial x} \right] + \frac{\partial}{\partial y} \left[ K_y \frac{\partial h}{\partial y} \right] + R = 0 \quad 5.4$$

Where:

$K_x$  and  $K_y$  = Components of the hydraulic conductivity along x, and y axes [ $LT^{-1}$ ]

$R$  = Flux per unit volume representing sources/sinks term [ $T^{-1}$ ]

$h$  = Hydraulic head [L]

#### 5.3.1. Data input for the Model

The input data that were previously processed and analyzed in chapter four were simulated by the model in accordance to how the computer code runs. The model was assumed to simulate the conceptual model. The processed DEM (aquifer top elevation) was imported in to the model after defining the model area and boundary conditions. The bottom elevation was taken from the cross-sections. The cross –sections are selected, in such a way that the volcanic and the alluvial aquifers are hydraulically connected. The General Head boundary condition was used to estimate the inflow from the mountain to the alluvial plain. The hydraulic conductivity values from the pumping test analysis of the alluvial aquifer were used as initial values for this aquifer in the model input. Due to data limitation, only 35 borehole coordinates and observed water level were imported to the model for calibration purpose.

### 5.3.2. Model execution and Calibration

Model calibration is the process of making adjustments, within justifiable ranges, to initial estimation of selected model parameters to obtain reasonable agreement between simulated and measured values. It requires the entry of organized input data into the selected computer code, and interpretation of the model results. These results were compared with the calibration target and if the error in the simulated results is acceptable, the model is considered as calibrated; if the level of error is unacceptable, the input parameter values are adjusted within a reasonable ranges and the model is run again until acceptable results are achieved. The model runs with the interactive method.

### 5.3.3. Calibration target and Uncertainty

In this study, the measured hydraulic heads from the field were used as a calibration value. The main purpose of calibration was to match the simulated head by the model with the measured head. However, most of the measured head data and uncertainty of the model are associated with errors. This is due to:-

- ❖ Measurement errors related to measuring device and operator/user.
- ❖ Errors due to averaging ground surface elevations from digital elevation models (DEM).
- ❖ The water level measurements are single time measurement.

Because of data limitation on the Waja-Golesha sub-basin, the calibration mainly focuses on the Hormat-Golina sub-basin. Due to all uncertainties, calibration becomes a challenging and tough task. The standard deviation of the groundwater level below ground surface from measured groundwater level showed a value of near to 7m. It was reasonable to accept a RMS error of 7m as calibration target due to the cumulative effect of the mentioned uncertainties in the input data (see Appendix C, Table C.1).

### 5.3.4. Trial and Error Calibration

Trial- and – error calibration was the first technique to be used and is still the technique preferred by most users (Anderson and Woessner, 1992). It is the process of manual adjustment of input parameters until the model simulates the measured heads within range of the error criteria. The model was calibrated for steady- state conditions, assuming constant recharge and steady discharge neglecting seasonal fluctuations. Calibration was done through trial and error by changing aquifer hydraulic conductivity, recharge and river bed material material conductance values. The steps followed for the trial-and-error calibration is shown in **Figure 5.7**.

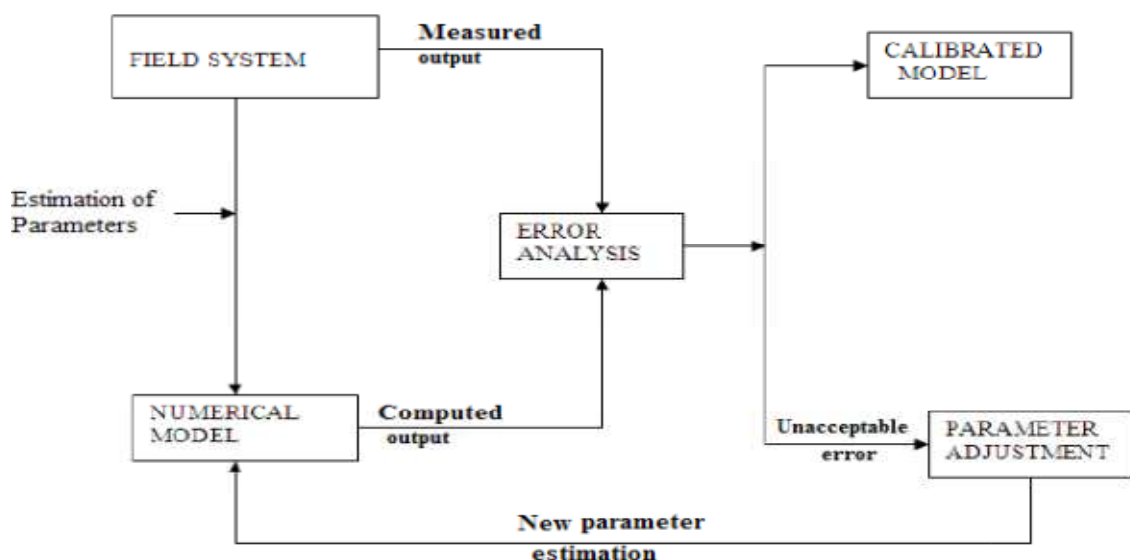

**Figure 5.7** Trial and error calibration procedures (adapted from Anderson and Woessner, 1992)

### 5.3.5. Evaluation of calibration

The results of the calibration should be evaluated both qualitatively and quantitatively (Anderson and Woessner, 1992). The mean of the observed and simulated heads differences was used to quantify the average error in the calibration process. The three ways of expressing the average difference between simulated heads ( $h_s$ ) and measured heads ( $h_m$ ) are the mean error (ME), the mean absolute error (MAE) and the root mean square error (RMS). The main target of the calibration is to minimize these error values.

$$ME = \frac{1}{n} \sum_{n_{i=1}}^n (h_{m,i} - h_{s,i}) \quad 5.5$$

The mean difference between measured heads and simulated

$$MAE = \frac{1}{n} \sum_{n_{i=1}}^n |(h_{m,i} - h_{s,i})| \quad 5.6$$

The mean of the absolute value of the differences in the measured and simulated heads

$$RMSE = \sqrt{\frac{1}{n} \sum_{n_{i=1}}^n (h_{m,i} - h_{s,i})^2} \quad 5.7$$

The average of the squared differences in measured and simulated heads (See Appendix C, Table C.1).

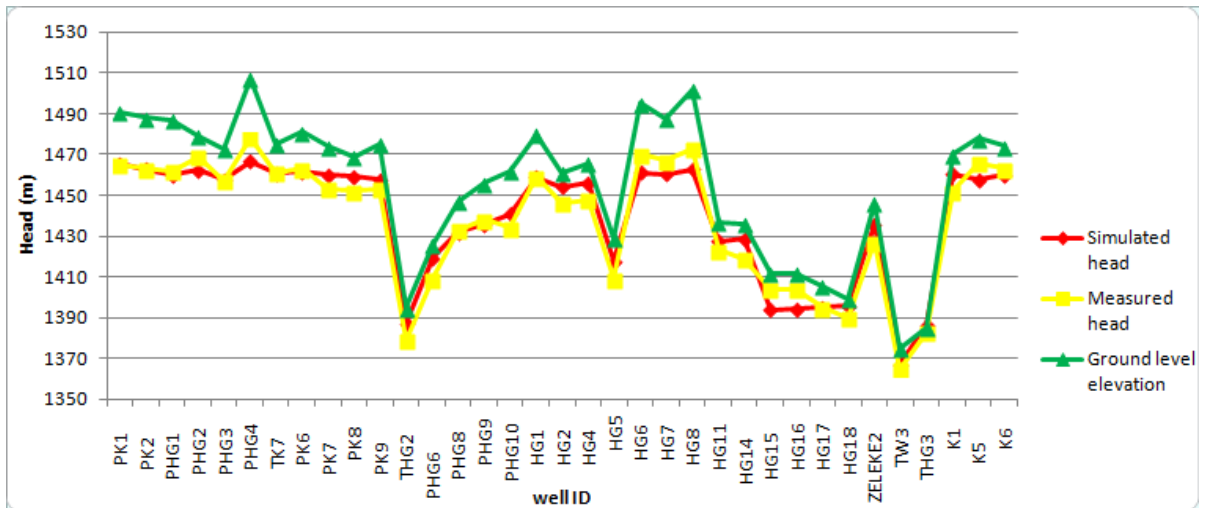

**Figure 5.8** Graphical comparison between the observed and simulated heads

The above error measures can only be used to evaluate the average error in the calibrated model. The RMSE is usually thought to be the best measure of error if errors are normally distributed. The maximum acceptable value of the calibration criterion depends on the magnitude of the change in heads over the problem domain (Anderson and Woessner, 1992).

The calibrated fit between the observed and simulated heads by the model generated scatter diagram is shown in **Figure 5.9**. The scatter plot has a value of RMSE of about 7m.

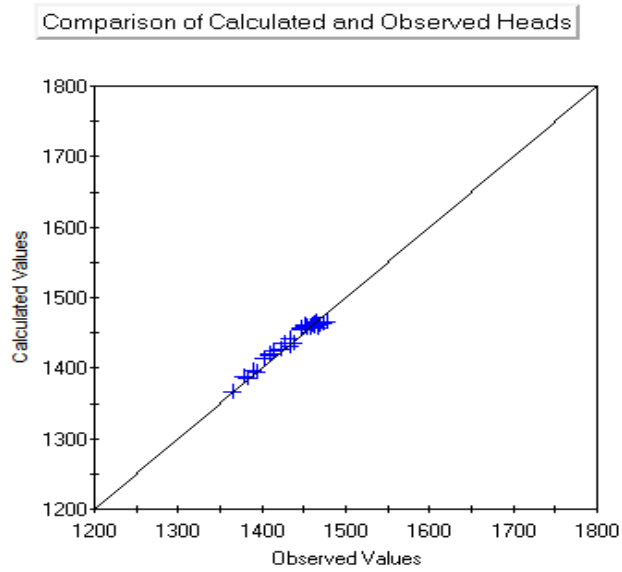

**Figure 5.9** The scatter diagram showing the comparison of measured and simulated heads  
 The differences in simulated and observed heads are tabulated in Appendix C, **Table C.1**.  
**Table C.1** Comparison of the Observed and Simulated Heads and Error Calculation

. The summary of the error analysis for the calibrated model is shown in **Table 5.2**

**Table 5.2** Error summary for the calibrated model

Type of error	Value (m)
ME	-1
MAE	6
RMSE	7



## CHAPTER 6

# Result and Discussion

---

## 6.1. Results

### 6.1.1. Water Budget of the model domain

The water budget for steady-state simulation is balanced (inflow minus outflow) within a percent discrepancy of [%] 0.00. In the model area, the inflow term includes the recharge and head dependent boundary whereas, the outflow term includes wells, river leakage and head dependent boundary. The water budget is calculated by water budget tool in MODFLOW. The model result shows both inflow and outflow are in balance which is consistent with the steady-state modelling theory (See **Table 6.1**).

The inflow-outflow balance simulated under the numerical model has some differences with that of the conceptual model. The balance for simulated is 118MCM for inflow which is similar to the outflow where as the balance for conceptual model is 95MCM for inflow which is equal to the outflow. The balance difference between the two is 23MCM which favours for the simulated balance. On the other hand, the simulated in flow 118 MCM is close to the valve of annual recharge of Kobo valley 119MCM calculated by CO-SAERAR study which was previously discussed in Literature review. This difference might be resulted from either from the data gap found during the analysis of the conceptual model as the pumping test for those wells drilled at the inlet and outlet areas of the two sub-basins is not conducted to evaluate the subsurface inflow-outflow.

**Table 6.1** Water budget of the entire model domain in  $\text{m}^3\text{d}^{-1}$

Flow term	IN	OUT	IN-OUT
wells	0	5192	-5192
Recharge	104232	0	104232
River leakage	0	57456	-57456
Head dependent bounds	218905	260489	-41584
Sum	323137	323137	0
DISCREPANCY [%]	0.00		

### 6.1.2. Sensitivity Analysis

Sensitivity analysis is the measure of uncertainty in the calibrated model caused by uncertainty in aquifer parameters and boundary conditions. Sensitivity analysis was performed by systematically changing the calibrated values of conditions (Anderson and Woessner, 1992). The main objective of a

sensitivity analysis is to understand the influence of various model input parameters and hydrological stresses on the aquifer system and to identify the most sensible parameter(s), which will need a special attention in future studies. By running the calibrated model for the respective changed values of the input parameter and comparing the result with the calibrated head, the parameter(s) sensitive to the model was established. The parameter values were varied within a reasonable range. Thus, it is important step in modelling studies. Accordingly, the model in this studied area is highly sensitive with decrease of the calibrated recharge and hydraulic conductivity values and relatively less sensitive with increasing these values which result in lower RMS error.

### 6.1.3. Pumping Scenario Analysis

In order to evaluate the response of the groundwater system under different groundwater abstraction rates, pumping scenario analysis were computed. The groundwater system response was compared with resulting changes in water level (drawdown) and groundwater outflow from the model domain. Even though, there was limitation in recording data how the groundwater has been abstracted currently, some estimation was done based on the information gained from project area. Three scenarios were used for analyses of the impact of well operation on drawdown: 1) current situation: 11 wells are operated simultaneously; 2) 35 wells are operated simultaneously and 3) 70 wells are operated simultaneously.

A total of about 27878 m<sup>3</sup>d<sup>-1</sup> of abstracted water was used in scenario-one to observe the effect pumping on the calibrated model. (See Appendix D, **Table D.1**).

In scenario-two, a total of 55825 m<sup>3</sup>d<sup>-1</sup> groundwater was assumed to be abstracted from 70 boreholes in order to see the effect of increased groundwater discharge over the concentrated boreholes as compared to model result (See **Table D.2**).The amount of water abstracted in scenario- two was increased by 50% from the amount used in scenario- one.

The model simulation result for scenario-one has shown that for a total of 27878 m<sup>3</sup>d<sup>-1</sup> of abstracted water from 35 boreholes was resulted in an average decline of groundwater level at the pumping well by about 14m for the entire model area. However, the decline in head slightly exceeds 25m at the borehole HG8 (See **Table 6.2**).

In scenario-two, for a total of 55825 m<sup>3</sup>d<sup>-1</sup> of abstracted water from 70 boreholes, the model simulation resulted in an average decline of water level by 32m for the entire model domain. Similarly, the decline in head reaches 45m at borehole HG8. Generally, the effect of increased groundwater abstraction is more pronounced in areas where there are more boreholes at close distance. The detailed average decline in groundwater head for both scenario-one and scenario-two can be seen in **Table D.3**

**Table 6.2** Estimated groundwater abstraction rate and the average decline in groundwater level for different pumping scenarios

	Number of bore holes	Total discharge (m <sup>3</sup> d <sup>-1</sup> )	Average decline in head (m) due to abstraction.
Current situation	11	5192	7
Scenario-one	35	27878	14
Scenario-two	70	55825	32

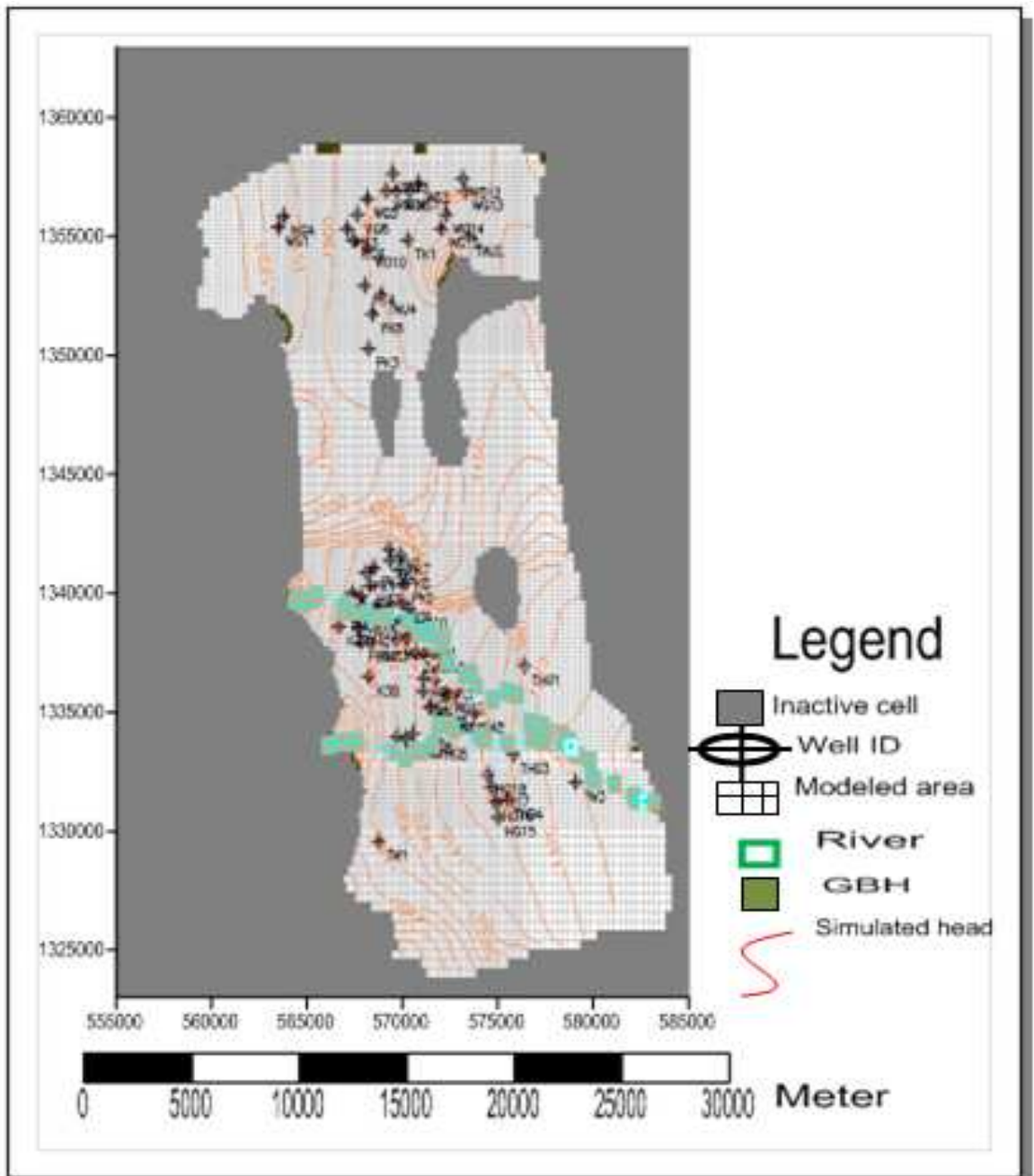

**Figure 6.1** The model simulated groundwater heads for pumping scenario-one

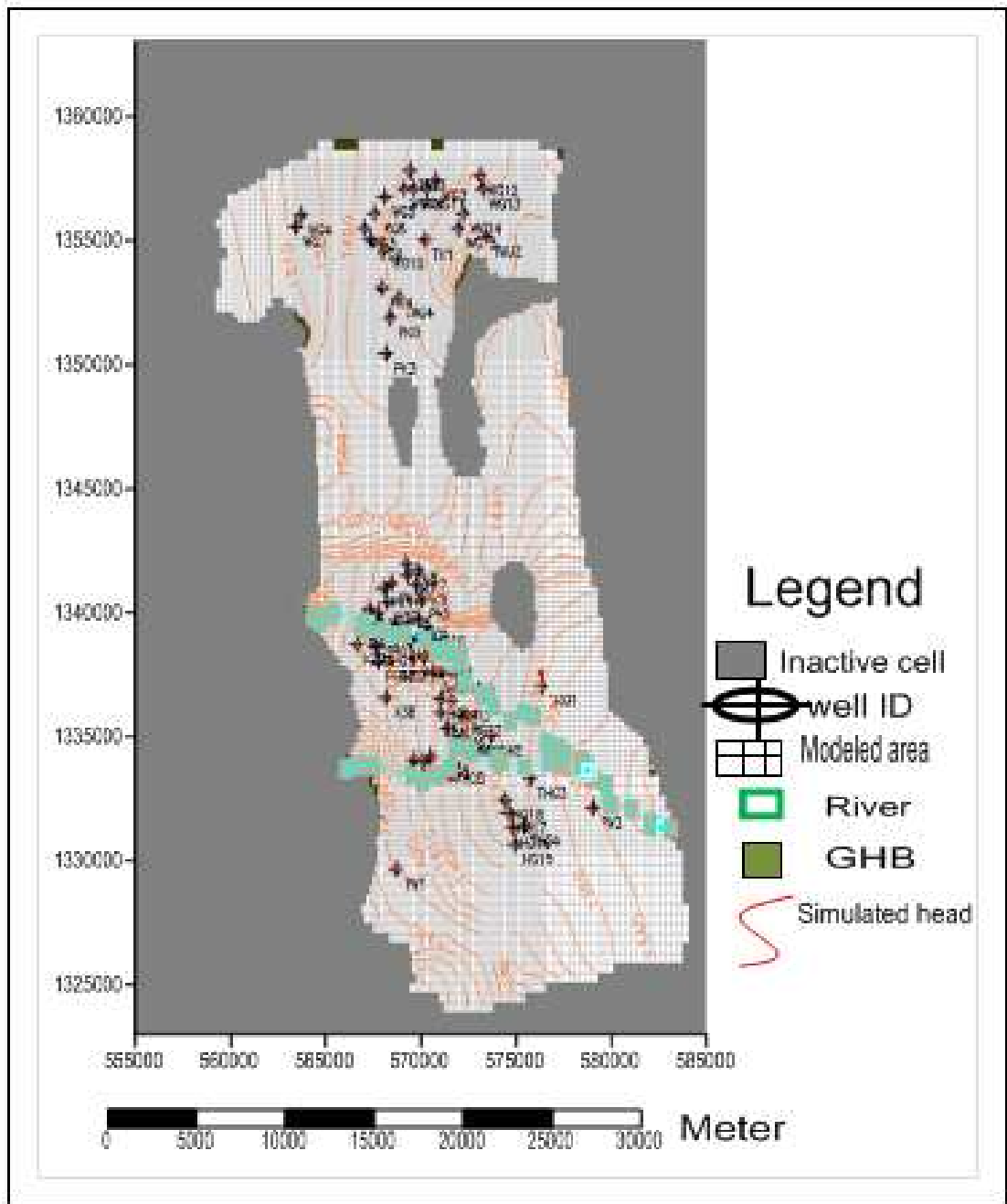

**Figure 6.2** The model simulated groundwater heads for pumping scenario-two

**Model simulated groundwater budget for different pumping scenarios**

The model simulated groundwater budgets for different pumping scenarios were processed for Kobo valley and the model results were shown in **Table 6.3** and **Table 6.4**.

**Table 6.3** Simulated water budget of Kobo-valley for scenario-one in  $\text{m}^3\text{d}^{-1}$

Flow term	IN	OUT	IN-OUT
wells	0	27878	-27878
Recharge	104232	0	104232
River leakage	0	57297	-57297
Head dependent bounds	227872	246929	-19057
Sum	332104	332104	0
DISCREPANCY [%]	0.00		

**Table 6.4** Simulated water budget of Kobo-valley for scenario-two in  $\text{m}^3\text{d}^{-1}$

Flow term	IN	OUT	IN-OUT
wells	0	55825	-55825
Recharge	104232	0	104232
River leakage	0	57291	-57291
Head dependent bounds	241064	232180	8884
Sum	345296	345296	0
DISCREPANCY [%]	0.00		

**Graphic comparison of the hydraulic heads simulated under different pumping scenarios.**

To compare the variation in head distributions, the model generated hydraulic heads under different scenarios were plotted together. (See **Figure 6.3**)

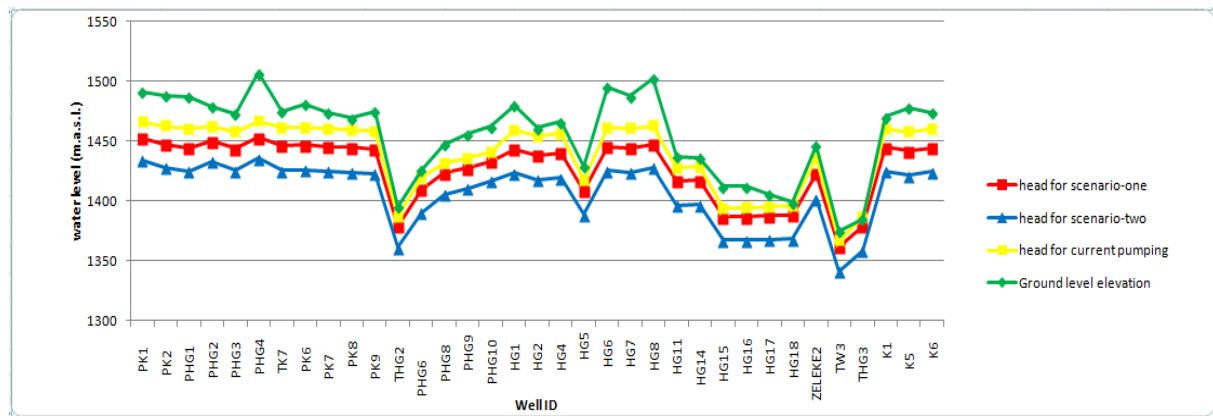

**Figure 6.3** Comparison between the observed and simulated heads of different scenarios

The decline in hydraulic head under both scenarios was more pronounced Hormat-Golina sub-basin of kobo valley, where there are relatively large numbers of discharging boreholes, which are closer to each other.

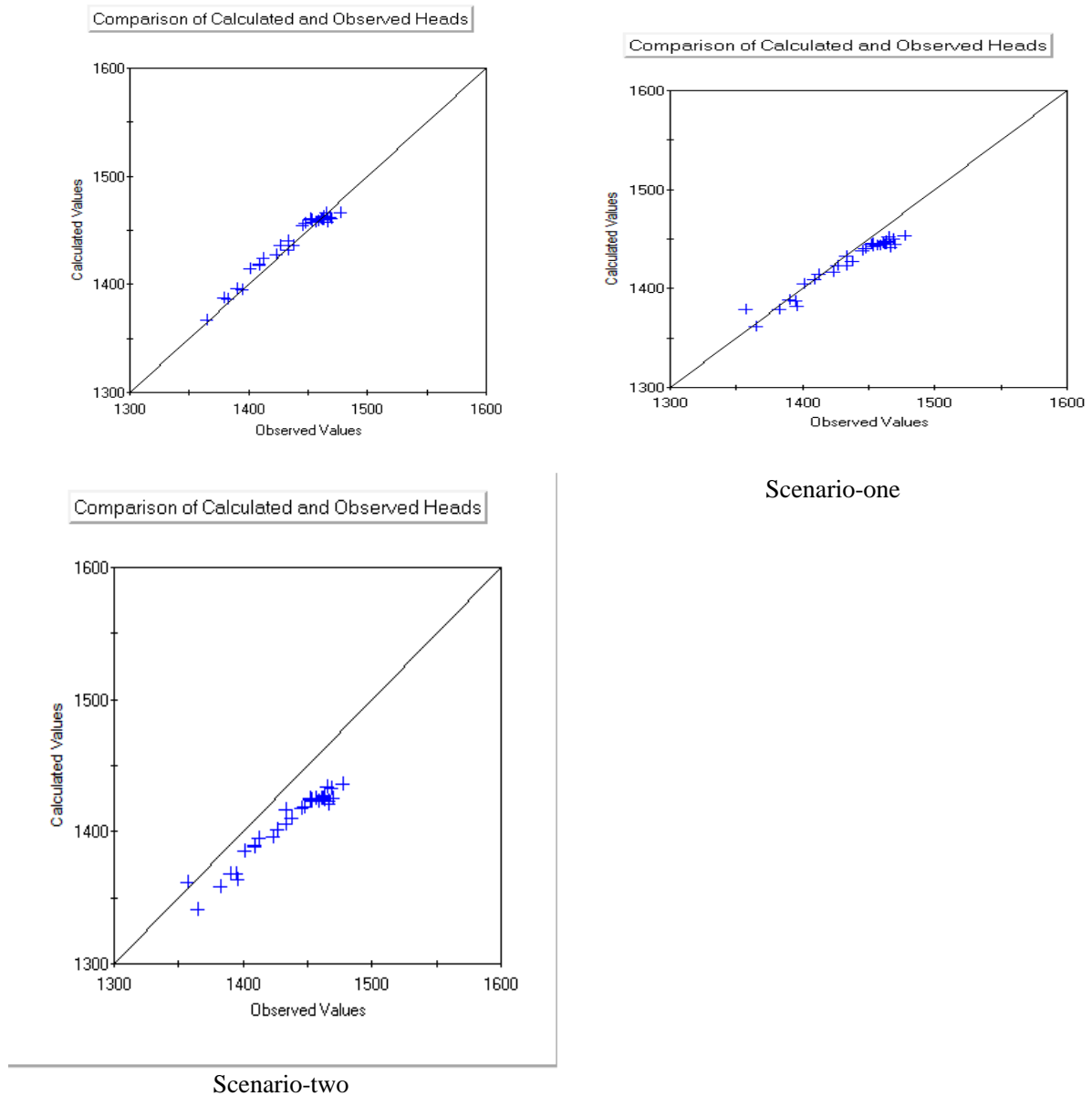

**Figure 6.4** The scatter plots of simulated versus observed heads for different pumping scenarios

#### 6.1.4. Estimation of Radius of influence and well interference

##### Radius of influence

The radius of influence of a pumping well can be determined in steady state for different aquifer systems (confined and unconfined). Radius of influence is the horizontal distance from the centre of a well to the limit of the cone of depression. It is calculated using different groundwater flow equations. For this study, a drawdown less than 20 % of the measured drawdown in the pumping well is taken as stabilized or insignificant drawdown based on the pump test data analysis which was conducted previously by Geo Engineering Service (GES, 2003) and Metaferia Consulting Engineers (MCE, 2009). The radius of influence is used for future plan of boreholes drilling. From **Table E.1**, It was seen that 12 wells had higher drawdown than the 20% drawdown at scenario-two based on the calculated draw downs of Hormat-Golina sub-basin.

### Well interference

Interference of the cone of depression of wells spaced closer to another will increase the drawdown in each well and consequently decrease the discharge per well. In order to estimate the drawdown interference of hypothetical wells for planning purpose, Muskat, (1937) formula was applied for two identical wells at a distance B apart. Well interference is computed for two identical wells in Hormat-Golina sub-basin for future well locations as follow;

$$Q = \frac{\pi k(d^2 - h_w^2)}{2.3 \log \left( \frac{R^2}{r_w B} \right)} \quad 5.8$$

Where Q = the discharge (m<sup>3</sup>/d)

$h_w$  = water column in the pumping wells (m)

$r_w$  = Well radius (m)

R = Radius of influence (m)

d = Saturated thickness (m)

k = Hydraulic conductivity of the aquifer (m/d)

B = well interference distance between two wells (m)

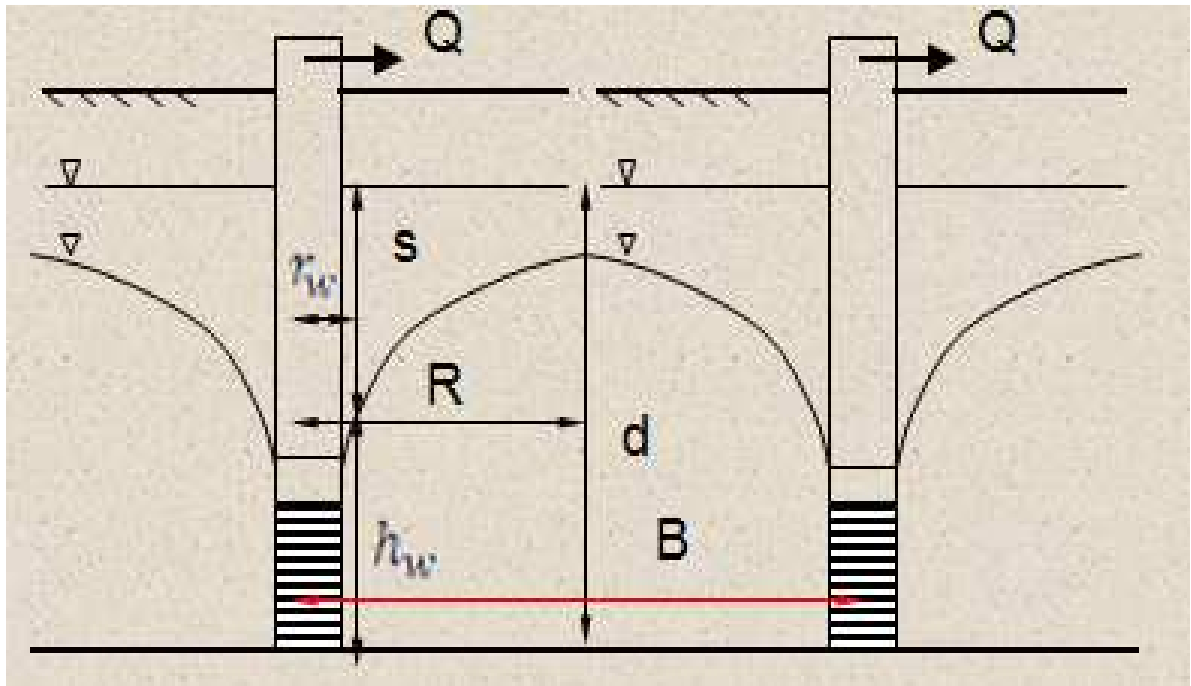

Figure 6.5 well interference in Hormat-Golina sub-basin

**Table 6.5** Well interference computation in Hormat-Golina sub-basin

Parameters	Hormat-Golina sub-basin
Type of aquifer	Unconfined
Radius of influence (m) *	250
Well interference distance (m) *	500
Discharge (m <sup>3</sup> /day)	4320
Radius of well (m)	0.254
Average depth (m)	142
Average SWL (m)	47
Average saturated thickness (m)	95
Average hydraulic conductivity (m/day)	7.08
Calculated hw (m)	88.44
Calculated drawdown at 250m from the pumping well(m)	6.56

Source: Pump test data

\* Assumed values

Based on the calculated horizontal distance, three pairs of wells (K6-HG6, K6-HG1 & HG6-HG8) have a radius of influence (209m, 229m & 235m) less than 250m respectively. The horizontal distance between two wells was calculated by taking the square root of the square sum of distances in Northing and Easting Hence; the drawdown of these wells is greater than the stabilized 20% drawdown at scenario-two. All wells have a drawdown less than 20% in scenario-one. From the field visit, it was mentioned that well HG8 has a problem in discharge decrease from initial 50l/s to 26 l/s. The model simulation also indicated that HG8 had a maximum drawdown of 26m and 45m in scenario-one and scenario-two respectively (See **Table E.1**). Therefore the well interference and the abstraction of all wells at a time is one of the causes for discharge decline.

### 6.1.5. Groundwater Reserve in Kobo Valley

The total subsurface water reserve is a function of saturated thickness and storage coefficient/specific yield. The aquifer system is generalized into water table aquifer of the sediment. The average saturated thickness is 139 m in Waja-Golesha and 95 m in Hormat-Golina sub basins. The groundwater reserve is computed applying the following formula.

$$V = Sy * A * H \quad 5.9$$

Where V= Reserve (m<sup>3</sup>)

Sy = Specific yield (0.1 for kobo valley taken from pump test data)

A = surface area of the aquifer (m<sup>2</sup>)

H = saturated thickness (m)

The groundwater reserve in Waja- Golesha and Hormat-Golina sub basins is summarized in **Table 6.6**



**Table 6.6** Groundwater reserve in Kobo valley

Sub-basin	GW potential area (km <sup>2</sup> )	Average saturated thickness(m)	Allowable extraction (MCM)
Hormat-Golena	127	95	1207
Waja-Golesha	86	139	1190
Total	213		2397

Source: Pump test data and this study.

### 6.1.6. Estimation of Allowable Exploitation of Groundwater

In this study, the allowable extraction of groundwater is taken to be 60% of the saturated thickness of the sediment. Accordingly, the exploitable amount of water reaches 714 MCM and 724MCM in Waja-Golesha and Hormat-Golina sub basins of the Kobo Valley respectively. Estimated abstraction is summarized in **Table 6.7**.

**Table 6.7** Allowable abstraction for 60% drawdown of the saturated thickness in Kobo Valley

Sub-basin	GW potential area (km <sup>2</sup> )	Number of existing wells	60% saturated thickness (m)	Allowable extraction (MCM)
Hormat-Golena	127	48	57	724
Waja-Golesha	86	22	83	714
Total	213	70		1438

Source: Pump test data and this study.

According to the availability of the exploitable groundwater amount, the number of irrigation wells to be used in each sub basin is determined in **Table 6.8** considering the following assumptions.

- ✚ 60% of the available groundwater amount will be abstracted on annual basis within 15 years period.
- ✚ Annual groundwater abstraction from the wells will be only for six months dry period from January to June.
- ✚ Annual groundwater abstraction from each well will be 0.8 MCM when used for six months; which means the abstraction rate from each well is assumed to be 50 lit/sec.

The annual recharge for each sub-basin calculated by using Darcy's approach was used to estimate the number of wells in kobo valley. This total recharge (83MCM) is less than the model calculated recharge (118MCM).The estimation of number of wells in the valley has good safety factor since calculation is made on the smaller recharge.

**Table 6.8** Estimation of the Available Groundwater Potential and Number of Wells in Kobo Valley

Sub-basin	15 years Abstraction (MCM )	Annual (MCM)	Annual Recharge (MCM )	Total Annual (MCM )	Total number of wells	Currently Existing number of wells	Additional Proposed Wells
Hormat-Golena	724	48	52	100	125	48	77
Waja-Golesha	714	48	30	78	97	22	75
Total	1438	96			223	70	152

### **6.1.7. Irrigation Water use efficiency**

Agriculture consumes the largest amount of water however; the water use is mostly inefficiency. With rapid population growth, the need for food and correspondingly water for irrigation is rising. There is an increasing demand due to urbanization and industrialization. Therefore efficient use of irrigation water to produce more is the only option. Increasing irrigation water use efficiency is possible through suitable crop selection, proper irrigation scheduling and effective irrigation techniques.

#### **Strategies to optimize Irrigation water use efficiency**

Farmers always ask questions how to improve irrigation water use efficiency to increase production. Making the right decisions related to crop selection, Irrigation scheduling and methods is imperative to improve irrigation water use efficiency. These strategies are used to reduce water and pumping costs, increase crop yield, and maintain a higher soil quality. Crops have different daily and total growing water needs. Maize was selected because of the sufficient added value and farmers' preference. Proper Irrigation scheduling can eliminate too much or too little water that is applied to crops. It integrates the time and depth of water applied to crops based on the water content in the crop root zone, crop development stage and the amount of water used by crop since it was last irrigated. In this studied area, the main target is to optimize water use efficiency at farm level due to high energy cost that consumes more fuels since it is not connected to a power. Therefore producing more crops with a drop of water is the only option. Optimum amount of water is available for plant needs through proper irrigation scheduling. Soil enhancement measures like proper field levelling and furrow diking is also important to improve the efficiency of irrigation practices.

### **6.1.8. Aqua crop Model to determine seasonal water requirement**

The approach to determine irrigation needs can done by running the Aqua Crop model for the selected crop-soil combination. The mode is determination of net irrigation water requirement along with the output of the generation of an irrigation schedule. The Aqua Crop model can predict the net irrigation water requirement and the water use efficiency.

#### **Model Input**

The average climatic data, soil, crop characteristics, field and irrigation management are needed to run Aqua Crop. In this study, fifteen year average monthly rainfall, minimum & maximum air temperature, reference crop evapotranspiration, and the default value of CO<sub>2</sub> were used. Reference evapotranspiration was calculated using the FAO ETo calc programme using the monthly minimum and maximum temperature and sun shine hours (See **Table 4.2**). Maize was selected for the crop characteristics since it needs more water and also longer growing period. Determination of net irrigation water requirement for more water consuming maize is used as a maximum margin to determine irrigation needs of other crops in the study area for water management on farm. The growing period was started in January. The dominant soil for the study area is clay loam. All the soil parameters were adjusted according to the soil type, clay loam. The groundwater has variable depth. In irrigation management, the mode ' Net irrigation water requirement' was selected and the allowable root zone depletion was 55 % Readily Available Water (RAW). Generation of irrigation schedule was done with 55 % allowable depletion of RAW for time criteria and back to field capacity on the depth criteria. The irrigation method was furrow. In filed management, the soil bund was taken as 0.1m. There was no surface runoff and mulches were not used.

## Model output

### Net Irrigation Requirement

The seasonal water-balance components and the net irrigation requirement of maize will be extracted from Aqua Crop simulation. It was found that 393mm net irrigation requirement, about 538mm ETo and 145mm rainfall for the cropping season (See **Figure 6.6** and **Figure 6.7** ).This net irrigation requirement exclude extra water that has to be applied to the field to account conveyance losses or uneven distribution of irrigation water on the field. The conveyance losses can be neglected for this study area since the means of transport of irrigation water from the well to the field is using closed pipes.

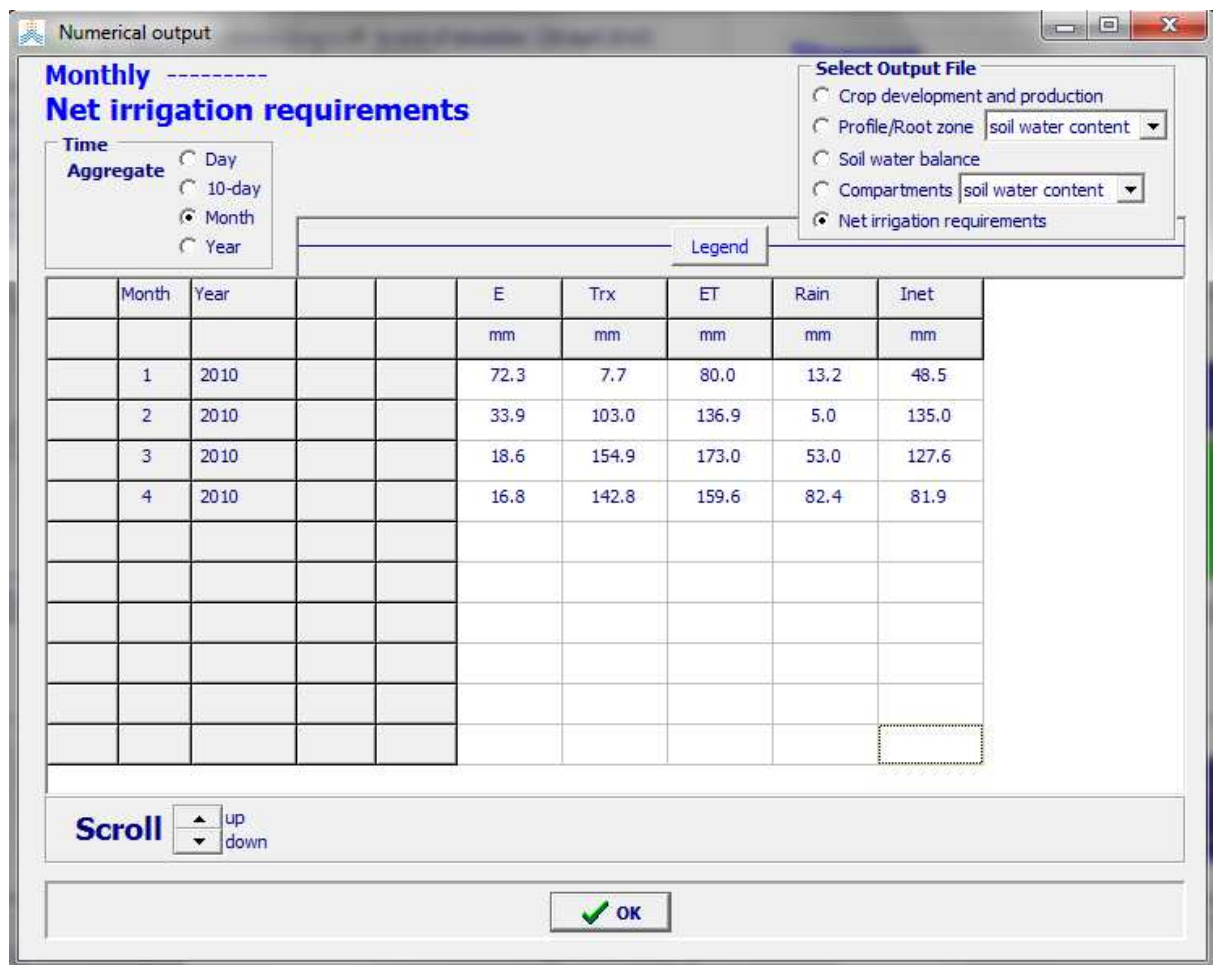

**Figure 6.6** Net irrigation requirement from Aqua Crop model.

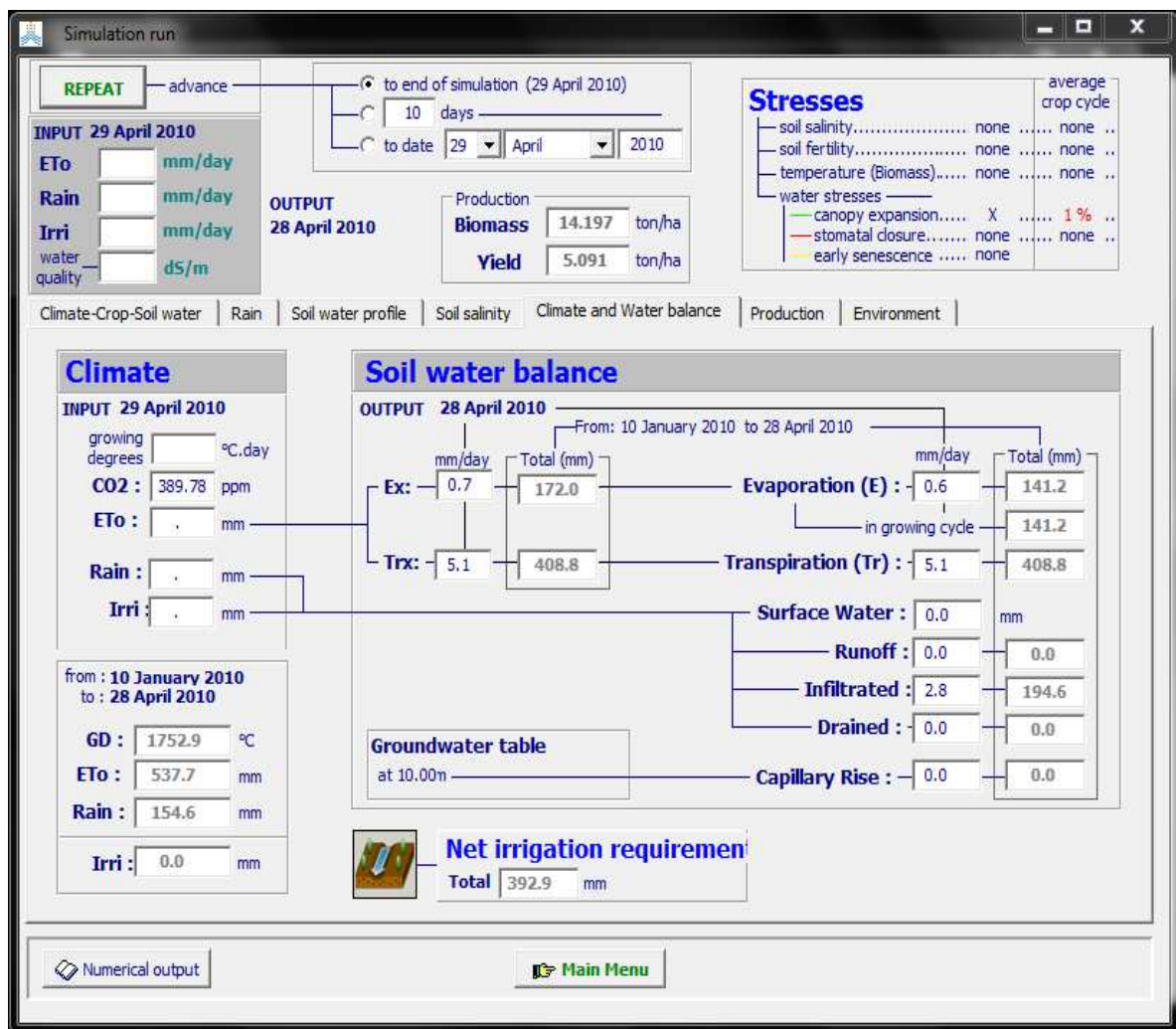

Figure 6.7 Soil water balance from Aqua Crop model.

### Generation of Irrigation schedule.

In the mode of generation of irrigation schedule, the allowable depletion was 55% on the time criteria and back to field capacity on the depth criteria. The soil water balance was resulted in 404mm of Irrigation needs after generation of irrigation events. The ET<sub>o</sub> and the rain fall values were the same as in the mode of net irrigation requirement (See Figure 6.8).

For optimization of irrigation water use efficiency, it is better to use 404mm of irrigation needs which later used in comparison of actually used irrigation water from the wells through pumping. The water application efficiency for maize was calculated from Figure 6.8.

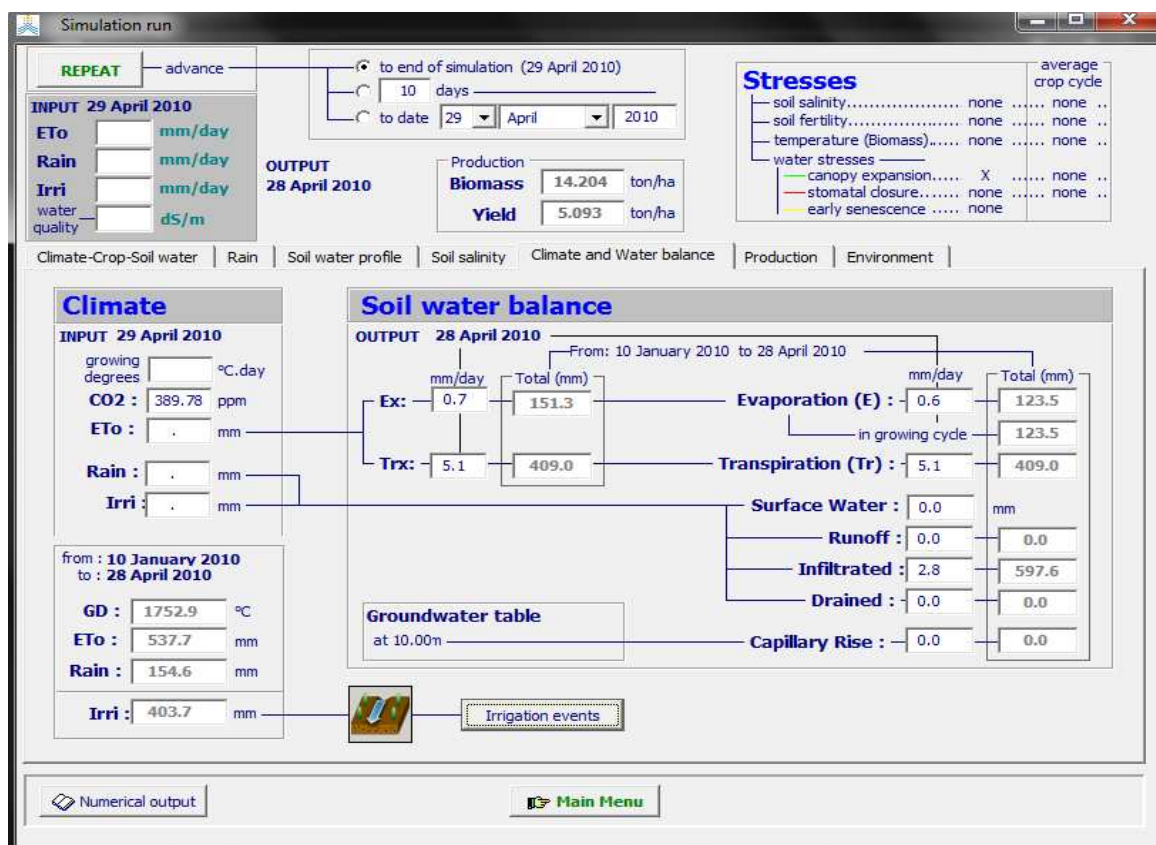

Figure 6.8 Soil water balance in generation of irrigation schedules.

### 6.1.9. Pumping Cost.

It is crucial to encourage farmers to keep a book for registering expenditures like cost of fuel, oil (lubricant) and spare parts to run the pump. Organizing trainings help farmers to compare their pumping cost with irrigated land (ha) and pumping costs to their overall production to improve irrigation management. The pumping cost and pump detail are given in **Table 6.9** and **Table 6.10** respectively. The existing condition uses 730mm of irrigation water on average from a well of 50l/s average discharge to irrigate an average of 45 ha of land. This irrigation demand consumes about 36480 litres and costs about 25536 euro annually. However, the irrigation demand from 80% efficiency is 584mm and uses about 29472 litres and costs about 20630 euro annually (see the existing abstracted irrigation water and pumping hours in **Table 5.1**). The water application efficiency of the existing condition can be estimated by dividing 404mm to 730mm which was resulted in 55%.

Table 6.9 Cost- Analysis of pumping in well

	Jan	Feb	Mar	Apr	May	Jun	Annual
Amount of water pumped(m3)	25920	51840	69120	69120	60480	51840	328320
Pumping (hr)	144	288	384	384	336	288	1824
fuel consumption(liter)	2880	5760	7680	7680	6720	5760	36480
Fuel price(Euro/liter)	0.7	0.7	0.7	0.7	0.7	0.7	
Pumping cost (Euro)	2016	4032	5376	5376	4704	4032	25536

**Table 6.10** Pump detail

Pumping discharge	50l/s
Head	100m
Pump power	92kw
Generator Capacity	247kVA
Fuel consumption	20l/h

Source: KGVDP Office

The cost benefit analysis of maize production in the current condition and new condition is shown in **Table 6.11**. This analysis considers only costs related to the amount of water lifted from the well. The other costs from preparation to harvesting were assumed similar in both conditions and were not included in this analysis due to data limitations.

**Table 6.11** Fuel cost-benefit analysis of Maize production

Description	Current condition	New condition
Yield (ton/ha)	1.8	1.8
Area (ha)	45	45
Production (ton)	81	81
Unit price(Euro/ton)	320	320
Production cost( Euro)	25920	25920
Irrigation demand(mm)	730	584
Fuel cost (Euro)	25536	20630
Net Income (Euro)	384	5290

Assuming that all other costs and benefits remain the same and only the fuel cost as variable, The net income from 45 ha under the current condition is low at 384 Euros because of the poor irrigation water use efficiency (55%) that leads to higher fuel cost. The net income between the current ( 55% water use efficiency) and the new condition (80% water use efficiency) is 4906 Euros for the whole 45 ha ( see **Table 6.11**) or about 110 Euros/ha.

Maize is the stable cereal crop with the highest current and potential yield from available inputs, at 2.2 tons per hectare in 2008/09 with a potential for 4.7 tons per hectare according to on-farm field trials, when cultivated with fertilizer, hybrid seed, and farm management practices\_ (Rashid, S., K. Getnet, et al. 2010).This yield is obtained by the farmers in other regions of Ethiopia. If we assume, we reach 4.7 ton/ha, the difference in net income from 45 ha between working at 55% and 80% efficiency will be 46826 Euros ( see **Table 6.12**) which is about 1000Euros/ha.

**Table 6.12** Fuel cost-benefit analysis of optimized maize production

Description	Current condition	New condition
Yield (ton/ha)	1.8	4.7
Area (ha)	45	45
Production (ton)	81	212
Unit price(Euro/ton)	320	320
Production cost( Euro)	25920	67840
Irrigation demand(mm)	730	584
Fuel cost (Euro)	25536	20630
Net Income (Euro)	384	47210

Irrigation financial management is also a key issue for sustainability of pump-fed irrigation system. It is crucial to guide and follow up farmers to save money for the fuel and maintenance costs even though pumps have been donated or subsidized initially by the government. Difficulty in financial management arises when the number of farmers increases. Up to 30 farmers is usually recommended in group-based irrigation.

## 6.2. Discussions

### 6.2.1. Water Balance Method and Darcy's Approach

#### Water Balance Method

Even though one of the objectives of this study was recharge estimation in the area, it is the most difficult tough task to evaluate groundwater resources since it needs the integration of all important processes, surface runoff, infiltration, evapotranspiration and groundwater level variations based on the limited data and no discharge measurement even on the main river Golina outlet. In this study, the water balance method was used to estimate groundwater recharge with very limited data. From chapter 4, it was found a value of 79mm/year (95MCM/year).The model simulated total recharge was resulted in 118 MCM. There is significant difference between the recharge from water balance method and model simulated due to the horizontal flux from the mountain aquifer as an important component of the model simulated recharge was not considered by the water balance method. Besides this, the runoff coefficient and soil moisture content used in water balance method was adopted from previous studies.

#### Darcy's Approach

Darcy's approach estimates the flux from a head gradient and transmissivity. However, the value for transmissivity doesn't represent the whole area of the two sub-basins of the valley rather a specific well value. The transmissivity of the soil is poorly identified because of heterogeneity and saturation. In spite of these limitations, the total recharge was 83MCM from Waja-Golesha about 30MCM and Hormat-Golina sub-basin about 53MCM.This recharge calculation was used to estimate the proposed number of wells in each sub-basin.

### 6.2.2. Groundwater modelling

Model calibration was achieved through trial and error approach until the simulated head fit the observed head values to a satisfactory degree. The calibration result indicated a reasonably match between simulated and observed heads with RMS error of 7m (See Appendix C, **Table C.1**).

From the contour map of simulated heads, it was noted that a flow direction is in agreement with the flow of conceptual model. Therefore, the calibrated groundwater flow for this study area especially the Hormat-Golina sub-basin was able to simulate the measured head.

The hydraulic conductivity values for the kobo valley aquifer were taken from pump test data analysis. The main target of this test was to evaluate well properties rather than aquifer properties and the values may be inaccurate to represent the whole model area. This may increase the uncertainty in the distribution of the parameter. Even though, the hydraulic conductivity obtained from pump test data analysis indicated high spatial variation, possible effort was tried to optimize the hydraulic properties during calibration process by considering the reasonable range of values from literature and pump test data analysis. The hydraulic conductivity obtained from pump test data analysis ranges from 1 to 20  $\text{md}^{-1}$ , on the other hand, model calibrated values mostly ranges 0.1 to 40  $\text{md}^{-1}$ .

### **6.2.3. Water budget of the model domain**

The water budget of the model domain is used to quantify and identify all flows in and out of the aquifer structure. This water budget of the model area quantitatively evaluates the amount of groundwater through an aquifer system. Even though, the in-flow and outflow components of groundwater system are the most difficult to calculate directly, both components were computed by the model. The total in-flow of the entire model area at steady-state condition was 118MCM /year ( $323137\text{m}^3\text{d}^{-1}$ ) and the out flow was also 118MCM/year.

### **6.2.4. Pumping Scenario**

In this study, the model was run for two pumping scenarios besides the current situation and the result was interpreted for each condition. In current condition, a total of  $5192\text{m}^3\text{d}^{-1}$  was abstracted resulting in an average decline of groundwater level at the pumping well about 7m. Similarly, a total of  $27878\text{m}^3\text{d}^{-1}$  and  $55825\text{m}^3\text{d}^{-1}$  abstracted water resulted in an average decline of groundwater level at the pumping well by 14m and 32m in scenario-one and scenario-two respectively. The drop in groundwater level is more observed where the wells are large in number and located at close distance from each other. For example in this study, wells K6 and HG6 have a close distance of 417m and their maximum decline of groundwater level in scenario-two was about 39m and 45m respectively.

### **6.2.5. Radius of Influence and well interference**

According to the calculated well interference of Hormat-Golina sub-basin, 12 wells had higher drawdown than the stabilized 20% drawdown at scenario-two (see **Table D.3**). Concentrated well pairs of K6-HG6, K6-HG1 and HG6-HG8 had a radius of influence 209m, 229m and 235 respectively. Currently, HG8 well has a discharge of 26l/s from initial discharge of 50l/s as it was reported in field visit. This decline in discharge might be due to well interference. The model reasonably finds the actual problem in the field.

### **6.2.6. Groundwater reserve and allowable exploitation**

The groundwater reserve of kobo valley was calculated as 2396MCM from Hormat-Golina and Waja-Golesha sub-basins reserve of 1206MCM and 1190MCM respectively. By taking the allowable extraction of groundwater is to be 60% of the saturated thickness of the sediment, Hormat-Golina and Waja-Golesha sub-basins have exploitable amount of water about 714MCM and 724MCM respectively. Based on the availability of exploitable groundwater amount and some basic assumptions (see Section 6.1.6), 77 additional wells for Hormat-Golina and 75 for Waja-Golesha sub-basins are proposed considering the minimum radius of influence is 250m and a distance between wells is to be 500m in order to locate the wells.

### **6.2.7. Aqua Crop model**

The Irrigation need of maize was determined from Aqua Crop simulation using the mode of generation of irrigation schedule. The seasonal soil water balance was calculated as 404mm. This irrigation amount doesn't include conveyance losses and uneven distribution of irrigation water on the field. In this irrigation system, the conveyances and distribution losses can be neglected since the



conveyance and distribution of water from the well to field are carried by closed pipes. The other components, ETo and rainfall were also determined as 538mm and 145mm respectively. The production from Aqua crop simulation was about 5 ton/ha. However, the existing production ranges from 7 to 18 quintal/ha which is similar with 0.7 to 1.8 ton/ha which was adopted from Kobo Girana Valley Development Project office and interviewing farmers. Maize is the stable cereal crop with the highest current and potential yield from available inputs, at 2.2 tons per hectare in 2008/09 with a potential for 4.7 tons per hectare according to on-farm field trials, when cultivated with fertilizer, hybrid seed, and farm management practices.(Rashid, S., K. Getnet, et al. 2010).The existing condition uses 730mm of irrigation water on average from a well of 50l/s discharge to irrigate an average of 45 ha of land. Therefore, water application efficiency of this irrigation (about 55%) can be improved up to 80% by making the right decision related to irrigation scheduling and irrigation methods simulated by Aqua Crop. The existing water application efficiency was calculated by taking 404mm irrigation water for six month to the amount of water delivered in to the farm (730mm), where as the new water application efficiency was calculated by taking 80% efficiency which resulted in 584mm. Hence the yield of maize will be increased up to 4.7 ton/ha and there will be a reduction of irrigation water demand from 730mm to 584mm and net income of 46826 Euros.

### **6.2.8. Model Limitation**

#### **Groundwater model**

Simplifications and assumptions during conceptual model development made the groundwater flow model to have limitations to represent the real world system. Due to poor quality of the existing data and limited data, the degree of uncertainty in the model was raised. In the modelling process like converting the real world in to conceptual and the conceptual in to numerical model may each step bring errors. The measured hydraulic heads were used as calibration targets. No independent measured heads were able to validate the model. Therefore the model was calibrated but not verified. Thus, the results from the model should not be interpreted as a perfect simulation but these results can be interpreted as a system response within reasonable and realistic model input parameters. Because of this limitation, the model may not be mainly used for detailed groundwater resource management uses.

#### **Aqua Crop model**

Even though Aqua crop model have many options for simulating irrigation needs like determination of net irrigation requirement and generation of irrigation schedules depending on the irrigation management practices, the provision for inserting the irrigation water application efficiency is not available for the irrigation methods in Aqua crop model except the percentage of wetting of fields.

### **6.2.9. Groundwater model and Aqua crop model**

The main aim of modelling the study area using Processing Mod-flow and Aqua Crop was to gain a better understanding of the groundwater system and improving irrigation water use efficiency in the studied sub-basins respectively. As it was previously mentioned in the result, there are still uncertainties concerning groundwater flow system and few in Aqua Crop simulations. These uncertainties can be minimized if possible removed through comprehensive data collection together with continued development of the models.

The groundwater model can be used for analysis of contaminant transport in the future. Since groundwater flow directions are a crucial aspect of the numerical model, more data collection is required to expand the knowledge relating to boundary conditions of the model domain.

Since the main focus for the development of groundwater resource is the unconsolidated sediment fill which is expected to be the main reservoir of sub-surface water, geological and hydro geological study of the valley should be further studied through comprehensive data collection in the future.

## CHAPTER 7.

# Conclusion and Recommendation

---

## 7.1. Conclusion

The study was conducted to provide better understanding in quantifying and abstraction of groundwater in Hormat-Golina and Waja-Golesha sub-basins of kobo valley by applying Processing MODFLOW. Aqua Crop model is also used to improve farm-level water management and optimize Irrigation water use efficiency. Based on the results obtained in the study, the following conclusion can be made.

The steady state model with pumping scenarios 11, 35 and 70 wells operating simultaneously indicated that groundwater abstraction of  $5192 \text{ m}^3\text{d}^{-1}$ ,  $27878 \text{ m}^3\text{d}^{-1}$  and  $55825 \text{ m}^3\text{d}^{-1}$  in the valley resulted in an average groundwater level decline due to abstraction (at the pumping well) of about 7m, 14m and 32m respectively. Operating more than 35 wells simultaneously, results in a negative balance between recharge and abstraction.

Assuming the pumping cost as the only variable cost and considering the current yield of 1.8 ton/ha, improving the water use efficiency from 55% to 80% increases the net income by 109 Euros/ha. If, however, the maximum maize yield of 4.7 ton/ha (this is harvested elsewhere in Ethiopia) is reached in the study area, the net income would increase by 1000 Euros/ha.

Kobo valley has exploitable groundwater reserve of 714MCM for Hormat-Golina and 724MCM Waja-Golesha sub-basins by considering 60% of the saturated thickness. Based on this amount of water, 77 wells for Hormat-Golina and 75 wells for Waja-Golesh sub-basins could be added without creating negative balance between recharge and abstraction.

The steady-state groundwater model set up and calibration put a better approach how to translate the conceptual model to the numerical model and realize the aquifer system of kobo valley. This is also useful for transient state groundwater modelling in the future study.

The calibrated steady-state groundwater flow model was able to reasonably simulate the hydraulic heads that match the measured heads. Moreover, the model simulated groundwater level contours indicated that the general hydraulic gradient in the valley follows the surface topography and agrees with the groundwater flow system defined in the conceptual model.

## 7.2. Recommendation

- ❖ Optimum simultaneous operation of a maximum of 35 wells is recommended keeping the minimum distance between two closer wells at 500m so as to avoid overexploitation and ensure sustainable use of groundwater resources.
- ❖ Kobo Girana Valley Development Project should create awareness to farmers about the real threat of very low water use efficiency and the resulting high pumping costs on sustainability of the well-based irrigation. The Project should work towards investment in power connection to minimize the reliance on fuel.
- ❖ Kobo Girana Valley Development Project should create awareness of the very low (1.8 ton/ha) maize yield in Kobo and introduce the already proven agronomic and farming practices that have led to a maximum of 4.7 ton/ha in other regions of Ethiopia.
- ❖ The output from this study can be used as a starting point for transient state groundwater modelling for better predictions of pumping effect and for better recharge simulation since recharge and groundwater outflow are strongly time dependent.
- ❖ Groundwater abstraction from irrigation as well as from water supply boreholes should be reported and recorded in data base periodically in order to evaluate seasonal and annual variations.
- ❖ Since there is no gauging stations along the main river like Golina and Hormat, river gauging stations together with Meteorological stations in the west mountain should be installed in order to improve data availability and better understanding of the sub-basins water balance.
- ❖ Geological and hydro geological study of the valley should be further studied through comprehensive data collection in the future since the main focus for the development of groundwater resource is the unconsolidated sediment fill which is expected to be the main reservoir of sub-surface water.
- ❖ Interested professionals can use MODFLOW for similar areas of interest.

## References

- Allen, G.R., Pereira, L.S., Raes, D. and Smith, M., (1998) Crop evapotranspiration-guidelines for computing crop water requirements. FOA Irrigation and drainage paper 56. FAO, Rome, Italy
- Anderson, M. P., and Woessner, W. W. (1992) Applied Groundwater Modeling. Acad. Press, San Diego, USA.
- Bear, J., (1979) Analysis of flow against dispersion in porous media- Comments. Jour. Hydrology, 40(3-4): 381- 385.
- Bos, M. G., & Nugteren, J. (1974). *On irrigation efficiencies* (Vol. 19). Wageningen: International Institute for Land Reclamation and Improvement.
- Chiang, W.H., and Kinzelbach, W., (2001) Processing MODFLOW (Version 5.3), A simulation system for modeling groundwater flow and pollution
- Chiang, W.H., and Kinzelbach, W., (2003) Processing MODFLOW Pro (Version 7.0.17), A simulation system for modeling groundwater flow and pollution.
- Chiang, W.H., Kinzelbach, W. and Rauch, R., (1998) Aquifer simulation model for Windows ASMWIN 6.0: Groundwater flow and transport modeling, an integrated program. Gebruder Borntraeger Berlin etc., 137 pp.
- Co-SAERAR (1997). Feasibility study of Report for the Kobo-Girana Valley Development Study Project, Volume III: Annex C: Hydrogeology
- Co-SAERAR (1997). Feasibility study of Report for the Kobo-Girana Valley Development Study Project. Volume III: Annex B: Regional geology.
- Co-SAERAR (1999). Feasibility study report for the Kobo-Girana Valley Development Study Project, Volume III: Annex C: Hydrogeology. The Commission for Sustainable Agriculture and Environmental Rehabilitation in Amhara Region.
- Deng, X. P., Shan, L., Zhang, H., & Turner, N. C. (2006). Improving agricultural water use efficiency in arid and semiarid areas of China. *Agricultural water management*.
- Fetter, C.W., (2001). Applied hydrogeology + Visual MODFLOW, Flow net and Aqtesolv student version software on CD-ROM. Prentice Hall, Upper Saddle River, 597pp.
- Freeze, R.A. & Cherry, J.A., (1997) Groundwater. Prentice-Hall, Englewood Cliffs, N.J., USA. 604pp
- Foster, S., (1998) Groundwater: assessing vulnerability and promoting protection of a threatened resource. Proceedings of the 8th Stockholm Water Symposium, 10-13 August, Sweden pp.79-90
- G.Castany, E.Groba, E.Romijn A new to understanding and Estimating Natural Recharge

- German Agency for Technical Co-operation (1977) Kobo-Alamata agricultural development program. Volume II: Annexes pedology and water development. German consults.
- Hagos, M. A. (2010). Groundwater Flow Modelling assisted by GIS and RS Techniques (Raya Valley-Ethiopia).
- Hsiao, T. C., Steduto, P., & Fereres, E. (2007). A systematic and quantitative approach to improve water use efficiency in agriculture. *Irrigation science*, 25(3), 209-231.
- Jyrkama, M.I., and Sykes, J.F., (2007) the impact of climate change on spatially varying groundwater recharge in the grand river watershed (Ontario). *Jour. Hydrology*, 338(3-4): 237-250.
- Kruseman, G.P. and de Ridder, N.A., (1992). Analysis and evaluation of pumping test data. International Institute for Land Reclamation and Improvement /ILRI, Netherlands, 377pp.
- McDonald, M. G., and Harbaugh, A. W. (1988) A modular three-dimensional finite-difference groundwater flow model. Techniques of Water-Resources Investigations 06- A1, USGS, 576pp.
- Metaferia Consulting Engineers (2009). Hydro geological investigation report for Kobo- Girana Pressurized irrigation project Final report. Unpublished Report.
- Muskat, M. (1937). The Flow of Homogeneous Fluids through Porous Media. New York: McGraw-Hill Book Company Inc.
- Shaw, E.M. (1994). Hydrology in practice. Third edition, Chapman & Hall.
- Sileshi Mamo (2007). Raya hydrogeology and isotope hydrological investigation project, final report. Ministry of Mines and Energy Geological Survey of Ethiopia.
- Todd, D.K., (2005). Groundwater hydrology. Wiley, Hoboken, NJ, 636pp.
- Rashid, S., K. Getnet, et al. (2010). "Maize Value Chain Potential in Ethiopia." Globalization and Markets program.
- RVDP (1998). Hydro geological study phase II feasibility draft report. Raya Valley Development study Project Tigray National Regional Government

## Appendix A Metrological Data

**Table A.1** Monthly Rainfall (mm) at Kobo station

Year	Jan	Feb	Mar	Apr	May	Jun	Jul	Aug	Sep	Oct	Nov	Dec	Annual
1996	79.00	0.00	31.00	75.00	133.00	53.00	147.00	205.00	67.00	18.00	64.00	0.00	872.00
1997	0.00	0.00	34.20	57.60	47.80	51.50	110.60	94.40	37.40	169.30	43.30	0.00	646.10
1998	53.90	1.60	24.10	38.90	11.70	3.80	316.10	311.80	50.90	6.10	0.00	0.00	818.90
1999	20.30	0.00	2.90	48.20	11.70	2.20	234.30	315.90	0.00	0.00	0.00	0.00	635.50
2000	0.00	0.00	1.50	76.10	42.00	3.70	226.70	240.00	48.10	87.80	24.10	83.40	833.40
2001	0.00	0.00	0.00	0.00	0.00	0.00	0.00	0.00	21.40	0.00	178.50	0.00	199.90
2002	22.30	2.50	499.00	493.90	13.00	2.90	100.10	0.00	0.00	16.00	0.00	66.60	1216.30
2003	41.20	32.70	34.80	60.00	32.80	11.00	140.00	258.00	34.70	0.00	0.00	42.80	688.00
2004	29.90	0.00	28.10	87.90	3.00	25.90	116.20	163.40	9.20	79.20	35.50	10.20	588.50
2005	8.30	0.00	34.00	158.20	125.60	2.80	131.10	190.90	42.40	8.70	64.80	0.00	766.80
2006	0.00	10.80	56.20	56.60	16.20	3.00	81.20	222.90	75.40	12.50	0.00	0.00	534.80
2007	17.80	11.80	36.90	46.60	7.70	29.00	80.00	220.70	70.00	10.00	0.00	0.00	530.50
2008	10.00	12.00	9.00	20.00	35.00	8.00	100.00	135.00	145.40	5.40	31.90	0.00	511.70
2009	6.00	5.00	6.70	40.00	50.00	1.40	145.90	123.90	6.60	51.60	22.10	51.70	510.90
2010	0.00	10.50	4.30	63.80	64.30	1.80	239.40	316.60	33.90	14.70	0.00	0.50	749.80
mean	19.25	5.79	53.51	88.19	39.59	13.33	144.57	186.57	42.83	31.95	30.95	17.01	673.54

**Table A.2** Monthly Rainfall (mm) at Alamata Station

Year	Jan	Feb	Mar	Apr	May	Jun	Jul	Aug	Sep	Oct	Nov	Dec	Annual
1996	132.90	0.00	69.20	123.40	115.20	25.00	76.50	250.00	36.30	8.00	58.20	0.00	894.70
1997	46.10	0.00	125.10	26.70	28.50	22.00	87.00	54.40	72.00	191.60	139.00	0.00	792.40
1998	179.00	23.40	25.50	35.20	19.50	0.00	348.00	271.90	63.50	17.60	0.00	0.00	983.60
1999	44.30	0.00	20.80	9.00	7.00	1.00	211.40	431.80	66.70	54.50	0.00	0.00	846.50
2000	0.00	0.00	10.00	43.50	74.00	0.00	246.20	450.10	68.40	14.80	83.30	72.80	1063.10
2001	0.00	0.00	157.90	12.80	29.50	16.80	224.80	244.30	24.80	10.00	10.00	2.50	733.40
2002	98.40	0.00	18.00	112.30	8.00	3.50	72.60	213.50	46.10	13.50	0.00	89.50	675.40
2003	75.80	69.50	41.90	94.20	24.50	12.70	111.80	234.20	22.80	0.00	0.00	66.90	754.30
2004	33.00	16.00	39.60	168.00	13.50	49.50	117.00	243.00	41.10	8.20	21.00	20.00	769.90
2005	21.30	1.40	110.30	131.60	65.80	24.00	141.50	167.00	33.10	6.00	0.00	0.00	702.00
2006	0.00	0.00	215.50	176.10	4.50	10.00	123.20	192.00	54.00	2.40	0.00	23.50	801.20
2007	12.30	46.30	8.40	109.00	20.00	15.00	165.10	214.70	50.90	0.00	0.00	0.00	641.70
2008	25.80	2.90	0.00	6.60	21.10	11.00	79.20	206.20	60.80	53.10	55.00	0.00	521.70
2009	0.00	0.00	0.00	89.40	0.00	0.00	93.20	68.00	0.00	0.00	27.50	10.00	288.10
2010	0.00	41.00	170.40	29.10	56.50	28.80	229.60	320.90	27.80	26.30	0.00	0.00	930.40
mean	44.59	13.37	67.51	77.79	32.51	14.62	155.14	237.47	44.55	27.07	26.27	19.01	759.89

**Table A.3** Monthly Rainfall (mm) at Zoble Station

Year	Jan	Feb	Mar	Apr	May	Jun	Jul	Aug	Sep	Oct	Nov	Dec	Annual
1996	40.00	12.00	90.00	100.00	13.00	10.00	250.00	312.00	110.00	25.00	0.00	0.00	962.00
1997	20.00	8.00	15.00	10.00	4.00	30.00	180.00	320.00	60.00	6.00	0.00	0.00	653.00
1998	30.00	18.00	22.00	28.00	0.00	45.00	260.10	300.00	43.50	46.40	0.00	0.00	793.00
1999	45.10	0.00	54.50	51.50	18.80	22.40	161.70	336.60	121.60	83.00	0.00	1.80	897.00
2000	11.60	0.00	7.10	106.50	73.50	11.10	280.00	358.50	48.40	167.50	78.30		1142.50
2001	35.00	1.60	62.90	7.30	111.90	21.80	216.80	200.00	60.00	50.00	9.50	2.90	779.70
2002	131.10	7.90	23.20	147.30	45.60	6.40	285.80	285.80	90.00	20.00	0.00	5.00	1048.10
2003	38.10	71.50	122.20	38.00	45.00	60.00	234.40	387.20	71.00	30.00	10.00	0.00	1107.40
2004	20.00	33.70	24.00	220.30	0.00	30.80	106.10	235.30	45.50	99.70	69.40	4.70	889.50
2005	10.00	25.00	80.40	109.30	83.50	1.40	171.50	137.10	42.40	0.00	50.30	0.00	710.90
2006	2.90	2.00	57.90	55.20	18.50	0.00	100.20	163.50	41.60	49.00	58.70	0.00	549.50
2007	82.00	8.00	35.00	120.90	4.50	79.60	294.40	368.90	128.00	21.20	9.30	0.00	1151.80
2008	20.20	10.00	0.00	5.80	14.50	15.60	108.50	287.20	132.40	85.00	238.90	0.00	918.10
2009	10.00	0.00	9.50	0.00	22.20	0.00	156.30	117.90	32.50	21.50	0.00	67.10	437.00
2010	5.00	15.00	30.00	50.00	18.00	4.00	120.00	180.00	150.10	15.20	0.00	0.00	587.30
mean	33.40	14.18	42.25	70.01	31.53	22.54	195.05	266.00	78.47	47.97	34.96	5.82	842.17

**Table A.4** Monthly Rainfall (mm) at Korem station

Year	Jan	Feb	Mar	Apr	May	Jun	Jul	Aug	Sep	Oct	Nov	Dec	Annual
1996	35.90	0.60	98.10	241.80		67.90	137.10		63.10	11.40	72.70	0.00	728.60
1997	9.90	2.00	97.70	50.70	92.90	63.60	172.10	55.90	58.80	322.60	164.10	1.10	1091.40
1998	159.60	38.50	26.70	27.80	80.20	12.40	397.20	355.80	212.30	45.60	0.20	0.00	1356.30
1999	65.80	0.00	2.80	49.80	12.80	32.10	234.90	350.10	112.20	44.50	2.20	0.40	907.60
2000	0.00	0.00	3.50	48.20	76.20	9.30	317.60	321.00	90.80	133.20	65.60	93.80	1159.20
2001	1.90	3.20	130.10	22.10	36.10	50.90	282.80	380.10	62.40	13.20	2.00	13.30	998.10
2002	65.30	0.70	34.10	107.00	15.60	3.00	137.20	228.60	90.30	8.00	0.00	92.60	782.40
2003	13.00	24.00	74.20	74.80	23.70	20.10	168.00	381.10	77.50	1.80	3.90	30.10	892.20
2004	13.90	6.00	40.90	55.00	1.90	54.00	143.60	249.10	65.50	34.80	21.90	9.90	696.50
2005	8.30	0.00	106.10	223.40	163.40	28.10	253.00	297.60	40.60	36.50	0.00	0.00	1157.00
2006	9.90	1.00	182.20	96.20	44.60	6.90	149.00	307.40	51.70	60.10	0.00	0.00	909.00
2007	58.10	21.00	68.80	40.00	15.00	9.00	313.40	388.50	32.60	10.00	27.50	0.00	983.90
2008	64.20	0.00	0.00	16.60	69.80	35.80	187.10	143.30	103.40	78.00	137.00	0.00	835.20
2009	2.20	0.00	44.20	49.30	4.70	6.50	230.60	176.20	32.20	67.70	0.00	0.00	613.60
2010	0.60	5.30	42.00	111.70	61.60	11.00	311.70	427.60	64.10	7.70	0.00	27.00	1070.30
mean	33.91	6.82	63.43	80.96	49.89	27.37	229.02	290.16	77.17	58.34	33.14	17.88	968.09

**Table A.5** Monthly Rainfall (mm) at Lalibela station

Year	Jan	Feb	Mar	Apr	May	Jun	Jul	Aug	Sep	Oct	Nov	Dec	Annual
1996	15.7	1.8	116.6	46.6	56.2	144.9	328.2	287.9	19.6	0.0	35.0	0.8	1053.3
1997	5.9	8.4	95.6	58.7	24.3	104.5	279.0	162.0	24.9	100.3	100.9	2.6	967.1
1998	19.3	7.7	26.6	11.8	44.0	15.8	337.0	258.6	58.1	21.5	0.0	0.0	800.4
1999	0.0	0.0	0.0	22.3	0.7	20.2	333.7	315.5	50.4	22.4	3.3	1.8	770.3
2000	0.0	0.0	25.9	79.9	13.5	16.2	213.1	206.3	71.1	80.7	0.0	0.0	706.7
2001	0.0	21.7	82.3	31.4	1.9	126.8	339.6	382.3	7.0	0.0	0.0	7.1	1000.1
2002	34.4	19.4	45.6	34.7	6.8	51.8	269.3	245.1	55.7	0.0	1.5	12.8	777.1
2003	2.0	19.7	44.2	58.1	1.8	55.5	203.9	426.7	55.2	0.0	1.6	0.0	868.7
2004	0.0	0.0	0.0	0.0	0.0	0.0	242.4	199.5	19.0	10.2	0.8	0.0	471.9
2005	6.2	21.4	53.4	27.1	57.0	36.4	328.1	165.7	40.2	0.5	0.0	0.0	736.0
2006	0.0	50.3	54.4	43.8	20.3	23.9	301.9	323.7	43.6	25.6	9.6	15.3	912.4
2007	39.5	10.7	5.3	21.7	23.3	195.7	250.4	197.9	88.7	0.3	3.8	0.0	837.3
2008	2.0	1.8	0.9	60.6	17.4	54.6	233.4	210.8	91.6	14.1	38.5	2.3	728.0
2009	0.8	2.8	29.8	10.4	2.3	5.2	239.3	203.4	20.2	24.6	22.9	0.0	561.7
2010	4.4	0.0	16.5	43.1	19.3	9.3	261.7	365.0	35.4	0.5	0.8	15.7	771.7
mean	8.7	11.0	39.8	36.7	19.3	57.4	277.4	263.4	45.4	20.0	14.6	3.9	797.5

**Table A.6** Monthly Tmax ( $^{\circ}$ C) at Kobo station

Year	Jan	Feb	Mar	Apr	May	Jun	Jul	Aug	Sep	Oct	Nov	Dec	Annual
1996				30.40	30.10	32.10	31.70	30.20	30.40	29.70	27.10	26.10	29.76
1997	25.40	27.90	29.00	28.00	33.00	33.30	31.30	31.40	32.40	27.60	27.10	27.20	29.47
1998	25.40	30.30	28.10	32.40	33.50	36.00	30.80	28.70	29.80	29.30	28.30	27.60	30.02
1999	26.80	30.40	29.00	32.10	34.20	35.30	30.50	29.70					31.00
2000		29.40	30.40	30.90	33.80	34.70	32.10	30.30	30.50	28.60	27.40	26.10	30.38
2001								29.40	30.60	30.40	28.40	28.40	29.44
2002	26.00	28.40	29.70	31.50	34.20	34.90	34.00			30.50	29.50	26.40	30.51
2003	25.90	29.00	30.20	30.90	34.00	34.60	32.20	30.00	30.80	30.20	29.20	25.90	30.24
2004	27.50	27.60	29.20	30.50	34.60	34.00	31.00	31.50	31.90	29.90	29.70	27.10	30.38
2005	26.89	30.24	31.33	31.52	31.79	35.11	32.69	32.23	27.75	30.77	29.20	28.32	30.65
2006	28.57	29.80	30.81	30.51	33.67	35.46	32.75	31.04	30.13	30.46		27.37	30.96
2007	25.37	28.87	31.38	31.45	34.79	34.45		30.25			28.30	27.40	30.25
2008									30.01	29.40	26.88	26.78	28.27
2009			30.58			35.95	32.28	31.50	32.23	29.65	29.60	26.61	31.05
2010	26.84	28.28	29.17	31.57	32.58	35.22	31.57	29.67	30.16	30.38	28.21	26.85	30.04
mean	26.47	29.11	29.91	30.98	33.35	34.70	31.91	30.45	30.56	29.76	28.38	27.01	30.16



**Table A.7** Monthly Tmax. (°c) at Alamata Station

Year	Jan	Feb	Mar	Apr	May	Jun	Jul	Aug	Sep	Oct	Nov	Dec	Annual
1996		29.50	30.90	30.80	30.80	32.60	32.40	31.20	31.60	31.20	29.00	28.40	30.76
1997	27.40	29.90	28.90	30.30	34.40	34.50	33.10	33.90	33.30	29.80	28.60	28.70	31.07
1998	27.00	27.70	30.50	34.50	34.50	36.10	31.80	28.80	30.70	30.80	30.40	29.80	31.05
1999	28.80	32.40	31.00	34.10	35.80		30.90	30.10	30.10	30.10	30.00	29.20	31.14
2000	29.70	31.60	32.80	34.20	35.20	36.80	33.20	30.50	30.50	29.30	29.00	26.80	31.63
2001	27.50	30.40	30.50	31.70	34.10	33.80	31.20	28.90	29.60	30.00	27.90	27.50	30.26
2002	24.70	28.00	29.80	30.40	33.70	34.30	33.60	30.60	29.40	30.70	28.80	26.30	30.03
2003	25.80	28.50	29.00	30.10	33.20	34.20	31.40	29.40	30.10	29.90	28.40	26.00	29.67
2004	27.10	27.10	29.50	28.60	33.40	32.80	31.90	29.60	29.50	29.10	28.40	26.30	29.44
2005	25.90	29.40	29.60	29.80	30.30	33.40	31.00	29.90	30.00	29.30	28.40	27.20	29.52
2006	27.30	29.50	28.50	28.00	31.30	34.40	30.50	29.70	29.90	29.90	28.60	27.60	29.60
2007	25.10	27.60	30.60	30.50			30.30		30.60	29.80		26.30	28.85
2008	26.90	27.70	30.80	32.10	32.90	32.50	32.10	31.90	32.10	30.10	27.30	26.70	30.26
2009	26.50	29.90	31.10	30.90	31.40	32.70	33.40	32.60	32.50	31.80			31.28
2010							26.30	25.40	27.10	28.10	24.70	23.30	25.82
mean	26.90	29.23	30.25	31.14	33.15	34.01	31.54	30.18	30.47	29.99	28.42	27.15	30.20

**Table A.8** Monthly Tmax. (°c) at Korem station

Year	Jan	Feb	Mar	Apr	May	Jun	Jul	Aug	Sep	Oct	Nov	Dec	Annual
1996	19.00	22.10	22.40	22.30	22.40	23.70	22.80	23.50	24.50	23.90	21.20	19.90	22.31
1997	19.80	21.60	22.30	22.40	24.90	24.70	23.30	24.10	24.90	21.40	21.00	21.10	22.63
1998	19.70	20.80	22.10	24.00	24.40	26.10	22.50	21.90	23.30	21.50	20.10	19.90	22.19
1999	19.30	22.30	21.70	24.20	25.90	27.30	22.00	22.70	24.30	25.10	24.60	21.50	23.41
2000	21.60	22.40	23.00	23.50	25.30	27.20	22.90	21.60	22.20	21.40	20.00	18.70	22.48
2001	18.00	20.30	20.30	22.50	24.40	24.50	22.70	21.60	22.10	21.30	19.60	19.90	21.43
2002	17.90	20.50	21.60	22.50	25.60	26.20	25.20	22.40	21.80	22.10	21.70	20.10	22.30
2003	20.30	22.40	22.40	22.60	24.60	25.50	22.40	21.70	22.30	21.40	20.90	19.40	22.16
2004	21.10	20.80	22.20	22.80	26.10	25.10	23.50	22.60	23.00	21.40	20.90	19.50	22.42
2005	19.90	22.90	22.70	22.80	23.00	25.30	22.80	23.20	23.20	22.10	21.10	20.30	22.44
2006	21.00	22.40	22.00	21.30	24.30	25.90	23.20	22.60	23.00	22.50	21.30	20.00	22.46
2007	18.50	21.40	23.50	23.50			23.20	22.80	23.40		22.30	19.60	22.02
2008	20.10	20.00	23.10	23.80	24.10	24.60	22.80	22.00	22.20	20.70	19.70	18.90	21.83
2009	20.20	20.90	22.30	22.70	24.50	26.90	22.60	22.40	23.30	21.90	22.30		22.73
2010	20.40	21.30	21.80	22.60	23.90	25.90	23.10	21.40	21.80	22.00	22.20	21.60	22.33
mean	19.79	21.47	22.23	22.90	24.53	25.64	23.00	22.43	23.02	22.05	21.26	20.03	22.36

**Table A.9** Monthly Tmin. (0c) at Kobo station

Year	Jan	Feb	Mar	Apr	May	Jun	Jul	Aug	Sep	Oct	Nov	Dec	Annual
1996					16.50	17.40	18.20	17.50	15.70	12.00	11.70	10.20	14.90
1997	13.30	12.30	15.90	16.70	17.50	18.70	18.80	17.80	16.30	15.50	15.60	11.80	15.85
1998	15.40	xx	17.20	18.10	17.90	20.70	17.90	17.20	16.10	14.50	10.10	8.40	15.77
1999	11.60	11.10	15.50	16.00	17.50	18.20	17.30	16.20					15.43
2000		10.60	14.20	16.50	15.60	15.90	14.90	11.80	7.10	9.40	7.70	7.20	11.90
2001													0.00
2002	14.50	13.00	16.00	16.40	16.90	19.20	19.60	xx	xx	13.20	12.10	15.20	15.61
2003	13.50	15.00	16.30	17.00	17.70	19.30	19.40	17.30	16.80	12.60	12.50	11.50	15.74
2004	14.90	15.00	14.40	16.80	16.50	18.30	18.10	17.70	15.60	12.20	12.70	13.90	15.51
2005	13.93	14.10	13.92	17.17	18.06	18.70	18.79	17.74	12.99	13.46	12.57	9.92	15.11
2006	13.08	15.59	15.86	16.37	18.13	19.92	19.10	17.62	16.08	14.89		15.26	16.54
2007	14.34	15.73	14.09	10.98	14.33	18.95		16.92			12.50	9.20	14.12
2008									16.31	14.02	12.47	11.38	13.55
2009			16.11			20.30	18.48	18.30	16.51	14.68	12.51	15.14	16.50
2010	13.37	15.39	16.25	17.85	17.84	20.33	18.86	17.32	16.06	13.94	11.47	11.24	15.83
mean	13.79	13.78	15.48	16.35	17.04	18.92	18.29	16.95	15.05	13.37	11.99	11.57	15.21

**Table A.10** Monthly Tmin. (°c) at Alamata station

Year	Jan	Feb	Mar	Apr	May	Jun	Jul	Aug	Sep	Oct	Nov	Dec	Annual
1996		12.90	16.00	16.40	16.10	16.10	16.70	16.30	15.50	13.90	12.70	11.50	14.92
1997	12.90	12.90	15.80	16.20	17.60	18.60	17.60	17.50	17.00	15.90	16.20	12.80	15.92
1998	14.90	15.00	16.60	17.90	18.10	19.90							17.07
1999	12.40	11.90	13.30	17.30	20.20		18.80	16.70	10.20	5.70	3.90	1.90	12.03
2000	2.30	5.30	6.60	7.90	10.10	11.40	11.60	9.20	8.70	7.90	6.50	6.30	7.82
2001	3.90	6.10	8.30		12.20	13.90	11.80	10.70	10.40	10.80	7.80	6.90	9.35
2002	9.50	14.40	17.00	17.70	18.60	20.00	19.70	16.70	16.70	15.90	15.40	16.00	16.47
2003	14.30	15.70	17.40	18.00	20.30	20.00	19.40	17.00	17.40	15.90	15.00	12.90	16.94
2004	14.60	8.80	10.10	16.10	18.00	19.50	18.70	17.80	17.10	15.40	15.20	15.10	15.53
2005	14.40	15.30	17.20	17.70	17.90	19.10	18.90	16.30	16.60	15.60	12.00	12.10	16.09
2006	14.00	16.20	15.50	16.40	17.80	19.10	17.60	16.30	16.50	16.50	15.80	15.60	16.44
2007	14.70	16.00	16.50	16.90			17.40		16.10	15.40		13.60	15.83
2008	13.70	13.70	14.40	15.50	16.00	15.70	14.90	13.70	14.00	13.80	13.90	13.50	14.40
2009	15.70	15.10	16.00	16.00	15.80	16.20	16.70	15.30	15.60	14.10	13.80		15.48
2010	11.80	10.20	11.60	11.90	13.50	12.50	9.00	8.70	11.10	13.90	13.30	11.10	11.55
mean	12.08	12.63	14.15	15.85	16.59	17.08	16.34	14.78	14.49	13.62	12.42	11.48	14.29

**Table A.11** Monthly Tmini. (°c) at Korem Station

Year	Jan	Feb	Mar	Apr	May	Jun	Jul	Aug	Sep	Oct	Nov	Dec	Annual
1996	7.90	5.70	9.90	10.20			11.80	12.00	9.20	4.10	4.50	3.20	7.85
1997	5.70	5.70	9.20	8.70	8.70	11.30	12.40	11.40	7.10	8.70	10.00	4.20	8.59
1998	8.50	7.50	9.60	9.30	10.20	9.80	11.90	11.80	10.20	7.00	1.10	-0.60	8.03
1999	3.40	1.70	6.50	7.40	8.60	9.70	11.60	10.60	8.40	6.90	0.40	2.30	6.46
2000	2.50	1.80	5.60	9.50	8.90	10.80	12.30	11.50	8.50	6.80	5.30	4.40	7.33
2001	3.30	3.30	8.50	7.20	9.20	11.80	12.30	11.90	8.20	6.80	2.50	2.00	7.25
2002	6.30	4.50	8.30	8.60	7.10	11.00	11.70	11.10	8.30	4.50	3.00	7.20	7.63
2003	4.30	2.20	3.80	10.10	9.80	11.20	13.10	12.10	9.90	4.10	4.50	2.80	7.33
2004	6.70	5.80	7.40	10.60	7.80	11.30	12.50	12.10	8.00	6.00	5.00	6.20	8.28
2005	7.30	5.40	9.70	9.80	10.50	10.40	12.60	11.80	9.90	5.00		6.90	9.03
2006	4.10	6.90	8.80	9.90	10.00	11.20	12.70	11.90	9.40	8.20	5.80	9.10	9.00
2007	8.30	9.30	7.00	10.30			12.50	11.90	10.00		4.40	1.30	8.33
2008	5.30	3.20	3.40	8.30	10.10	11.00	12.40	11.80	9.10	5.50	4.90	2.60	7.30
2009	3.80	4.40	7.60	8.00	7.10	9.30	11.50	11.20	6.70	3.80	1.80		6.84
2010	4.80	6.30	7.50	9.90	10.30	11.80	12.30	12.10	9.50	5.40	2.60	4.80	8.11
mean	5.48	4.91	7.52	9.19	9.10	10.82	12.24	11.68	8.83	5.91	3.99	4.03	7.81

**Table A.12** Monthly average wind speed (m/s) at Kobo Station

Year	Jan	Feb	Mar	Apr	May	Jun	Jul	Aug	Sep	Oct	Nov	Dec	Annual
1996	2.60	2.00	2.10	2.00	1.60	1.80	2.10	1.70	1.20	1.30	1.50	1.60	1.79
1997	1.80	2.00	2.10	2.00	2.20	1.90	2.00	1.70	1.60	1.40	1.30	1.40	1.78
1998	1.60	1.70	2.00	2.20	2.00	2.50	2.20	1.60	1.10	1.30	1.40	1.50	1.76
1999	1.60	1.80	2.20	2.10	2.10	2.30	2.00	1.50	0.00	0.00	0.00	0.00	1.30
2000	1.60	1.80	2.20	1.80	1.70	2.20	2.20	2.00	1.50	0.00	0.00	0.00	1.42
2001	1.50	1.70	1.70	1.40	1.20	1.40	0.50	0.80	0.20	1.60	1.70	1.80	1.29
2002	1.80	1.80	1.90	1.80	1.40	2.30	2.10	1.80	0.90	1.00	1.30	1.50	1.63
2003	1.60	1.70	2.00	1.90	1.50	2.00	2.00	1.40	1.00	1.10	1.30	1.30	1.57
2004	1.70	1.90	2.00	2.00	1.80	2.10	2.20	1.50	1.10	1.20	1.30	1.60	1.70
2005	2.00	2.10	2.20	2.00	1.60	1.90	2.00	1.80	1.20	1.20	1.30	1.50	1.73
2006	1.50	1.80	2.00	1.50	1.60	2.00	2.20	1.80	1.20	1.40	1.50	1.60	1.68
2007	1.80	1.50	1.80	2.00	1.40	1.80	2.00	1.60	0.90	1.00	1.20	1.40	1.53
2008	1.70	1.80	2.00	1.80	1.80	1.50	2.10	1.40	1.00	1.40	1.40	1.60	1.63
2009	2.00	1.80	2.10	1.70	1.50	2.00	1.80	1.80	1.10	1.00	1.20	1.50	1.63
2010	1.80	2.00	2.00	1.80	2.00	1.80	2.00	1.50	1.20	1.20	1.40	1.60	1.69
mean	1.77	1.83	2.02	1.87	1.69	1.97	1.96	1.59	1.01	1.07	1.19	1.33	1.61

**Table A.13** Monthly average sunshine (hour) at Kobo station

Year	Jan	Feb	Mar	Apr	May	Jun	Jul	Aug	Sep	Oct	Nov	Dec	Annual
1996	6.80	5.30	7.90	9.60	9.90	8.50	4.00	5.10	6.80	9.60	9.90	8.80	7.68
1997	8.00	7.30	9.30	6.90	9.40	6.20	3.10	5.10	7.30	9.50	9.70	8.10	7.49
1998	6.30	7.50	8.90	9.50	9.20	6.80	6.70	7.40	6.00	7.10	9.00	7.00	7.62
1999	6.90	4.40	8.70	6.60	9.10	6.30	6.10	6.50	7.00	9.60	10.10	9.30	7.55
2000	9.30	7.20	6.10	7.60	9.10	5.10	5.20	5.10	5.10	8.20	9.30	8.70	7.17
2001	8.00	7.40	8.90	7.90	9.80	8.30	3.40	6.60	7.10	7.90	8.10	7.90	7.61
2002	7.80	8.60	8.70	9.70	6.50	5.70	4.00	5.80	7.70	8.90	9.10	8.50	7.58
2003	8.70	10.20	8.10	9.00	6.80	6.40	8.30	7.10	6.70	7.30	8.60	9.00	8.02
2004	8.10	8.70	9.00	6.80	7.20	6.10	7.30	5.60	6.20	8.10	9.90	9.40	7.70
2005	8.00	8.00	9.00	9.20	9.00	6.00	5.00	5.60	7.20	9.00	9.70	8.80	7.88
2006	7.00	8.00	8.10	9.00	9.40	5.60	4.00	6.00	7.00	8.00	9.60	9.00	7.56
2007	6.50	7.50	8.00	9.60	9.10	7.00	3.50	5.50	6.80	8.40	9.00	8.50	7.45
2008	8.10	8.60	9.00	8.00	9.80	7.50	6.00	5.00	7.00	8.00	9.40	8.60	7.92
2009	9.00	10.00	8.00	9.20	9.40	6.40	4.60	6.20	6.90	7.00	10.00	9.20	7.99
2010	8.00	8.50	9.00	8.60	7.60	5.70	6.00	5.60	6.70	8.60	9.00	8.00	7.61
mean	7.77	7.81	8.45	8.48	8.75	6.51	5.15	5.88	6.77	8.35	9.36	8.59	7.65

## Appendix B

## Pump Test Data

**Table B.1** Hydraulic parameters of the alluvial sediment aquifer

Well ID	Location			Observation well	Depth (m)	SWL (m)	DWL (m)	Q (l/s)	DD (m)	Tav (m <sup>2</sup> /d)	Kav (m/d)	S	Sy
	X	Y	Z										
HG-1	568171	1339140	1480		112	20.59	41.49	51	20.9	225	2.3		
HG-2	569552	1339024	1461		91	15.1	30.6	51	15.5	433	6.2		
HG3	569659	1338130	1455		111	21	59.1	20	38.1	25.06	0.84		
HG4	569354	1339493	1466		109	17.55	33.21	51	15.66	259.2	7.2		
HG-5	571782	1333845	1429.0		112	19.97	34.4	50	14.43				
HG-6	567804	1339909	1495.0		101	24.83	36.09	50	11.26				
HG-7	568283	1340339	1487.5		105.5	20.7	52.75	50	32.05				
HG-8	567346	1340-10	1502.0		110	28.73	38.4	50	9.67				
HG-9	569905	1339618	1461.0		100	26.1	80.9	10	54.8				
HG-10	570348	1339366	1455.0		100	24.2	61.89	34	37.69				
HG11	571055	1335915	1437		116.5	14.4	35.17	50	20.77	230.5	5.52		
HG12	572295	1335804	1417		110.3	16.3	30.72	50	14.42	218.5	5.2		
HG13	571683	1336365	1425		110.6	18.26	31.61	50	13.35	239.6	5.7		
HG14	571067	1336466	1436		108.5	16.66	29.53	50	12.87	318.2	7.58		
HG-15	574995	1330597	1412.0		117	8	19.14	50	11.14				
HG-16	574870	1331228	1412.0		99	8.5	44.05	25	35.55				
HG-17	574671	1331878	1405.3		120	10.12	26.65	50	16.53				
HG-18	574472	1332357	1399.0		119	9.25	25.05	50	15.8				

Zelege1	570187	1338097	1452		113	20.4	37.9	50	17.5	276		
Zelege2	570658	1337490	1446		110.5	19.05	38.53	50	19.48	345		
PHG1	567688	1338578	1487	PHG1	129	24.35	29.24	50	4.89	1245	13.53	0.55
PHG2	567801	1337977	1479	PHG2-OB1	150	18.92	19.41	45	0.49	3145	44.9	0.28
PHG3	568356	1337982	1473	PHG3	156	16.63	25.89	50	9.26	513.5	4.94	3.10E-02
PHG4	566854	1339244	1507	PHG4-OB1	128	27.96	32.39	45	4.43	1412	22.75	0.31
PHG5	571398	1335248	1432		155	21.5	40.01	57	18.51	244	8.13	0.25
PHG6	571821	1334963	1426	PHG6-OB1	178	20.13	25.85	58.5	5.72	1017	23.1	0.29
PHG7	572289	1334951	1419		180	17.53	33.04	51.6	15.51	255	4.7	0.2
PHG8	570553	1334124	1447		147	20.61	37.93	46.4	17.32	267.5	5.6	0.22
PHG9	570089	1333952	1456	PHG9-OB1	158	21.67	27.25	53.5	5.58	1427	29.8	0.3
PHG10	569560	1334010	1462		146	25.1	30.88	59.5	5.78	1412	31.4	0.25
TW1	568755	1329590	1367		114	58.78	62.69	7	3.91	236		
TW3	579090	1332043	1375		81	13.3	38.01	29	24.71	140		
THG1	576123	1336656	1384	THG1-OB1	118	16.21	31.02	32	14.81	350.7	11.7	0.18
THG3	575801	1333260	1385	THG3-OB1	212	3.1	16.61	57	13.51	571	9.51	0.0012
THG4	575471	1331124	1408		175	5.2	12.47	62	7.27	906.5	16.8	0.0018
K37	566652	1338642	1515		57.7	35.7	36.7	2.5	1	7.9	0.2	
K38	568228	1336496	1464		56.5	22.7	23.7	4.2	1	1038	6.7	
K42	573764	1334973	1402		44.3	12.3	16.6	4.5	4.3	424	5.3	
K1	567803	1339502	1470		120	18		10				
k5	568625	1339470	1478		120	12		38				

k6	567887	1339500	1474		120	11		38					
TK1	570275	1355009	1418		164	19.63	61.48	75	41.85				
TK7	569334	1341467	1475	TK7-OB1	160	14.27	18.96	50	4.69	486.5	3.99		0.26
PK1	568066	1340931	1491	PK1-OB1	170	25.54	34.54	55	9	280	3.04		0.22
PK2	568476	1341101	1488	PK2	137	23.56	39.13	80	15.6	341	4.06		0.57
PK3	568204	1350350	1440		153	30.45	37.33	70	6.88				
PK4	568000	1353000	1436		106	9.14	61.2	60	52.06				
PK5	568427	1351843	1428		118	17.08	50.4	30	33.32				
PK6	569299	1341890	1481	PK6	145	17.52	32.55	40	15	198	2.61		0.29
PK7	569892	1341651	1474	PK7-OB1	203	20.34	23.55	40	3.21	577.5	7.41		0.06
PK8	569814	1341065	1469	PK8	181	17.98	37.16	50	19.2	168	1.43		0.37
PK9	569485	1341610	1475	PK9	145	23.85	29.76	50	5.91	768.5	8.35		0.19
WG1	563443	1355457	1505		104	13.3		51	13.4	1079	8.3		
WG2	570825	1357345	1417		130	18.7		40	32.3	147	1.3		
WG3	567035	1355424	1453		110	13		7	66.5	40.18	1.34		
WG4	563723	1355956	1496		118	13.16		52	12.76	315.4	5.28		
WG5	568109	1356681	1444		111	19.65		52	10.55	373	7.1		
WG6	569681	1357025	1429		105	25.61		50	18.72	181.4	5.05		
WG7	569106	1357024	1435		105.5	24.43		50	30.97	506			
WG8	567608	1356024	1447		105	10.19		50	10.17	797.8	18.99		
WG9	567405	1354956	1446		105	19.15		30	35.02	432	10.28		
WG10	568148	1354589	1437		106	16.59		50	10.41	1041	2.47		
WG11	570347	1357013	1423		104	18.7		50	20.1	227.8	5.42		
WG12	573140	1357524	1399		111.3	20.3		50	25.85	1171	2.8		
WG13	573250	1357002	1399		116.1	20.3		50	25.85	790.6	18.86		
WG14	572214	1356017			110	27.02	56.76	25					

WG15	572027	1355422			114	30.42	54.31	10				
TWJ2	573465	1355068	1398		121	23.95	77.81	15	53.86			
TWJ3	569491	1357769	1433	TWJ3-OB1	154	16.46	23.92	60	7.46	624.3	6.24	2.00E-04
TWJ4	568854	1352624	1425		199	15.58	40.49	60	24.91			

---



## Appendix C Error evaluation

**Table C.1** Comparison of the Observed and Simulated Heads and Error Calculation

No	well ID	Hs	Hm	Hm-Hs	Hm-Hs	Hm-Hs ^2
1	PK1	1465.658	1465.000	-0.658	0.658	0.432964
2	PK2	1462.638	1463.000	0.362	0.362	0.131044
3	PHG1	1460.117	1462.000	1.883	1.883	3.545689
4	PHG2	1462.117	1469.000	6.883	6.883	47.375689
5	PHG3	1457.581	1457.000	-0.581	0.581	0.337561
6	PHG4	1466.488	1478.000	11.512	11.512	132.526144
7	TK7	1460.849	1461.000	0.151	0.151	0.022801
8	PK6	1461.383	1463.000	1.617	1.617	2.614689
9	PK7	1460.036	1453.000	-7.036	7.036	49.505296
10	PK8	1459.325	1452.000	-7.325	7.325	53.655625
11	PK9	1457.864	1453.000	-4.864	4.864	23.658496
12	THG2	1386.968	1379.000	-7.968	7.968	63.489024
13	PHG6	1419.13	1409.000	-10.130	10.13	102.6169
14	PHG8	1431.608	1433.000	1.392	1.392	1.937664
15	PHG9	1435.519	1438.000	2.481	2.481	6.155361
16	PHG10	1440.718	1434.000	-6.718	6.718	45.131524
17	HG1	1458.944	1459.000	0.056	0.056	0.003136
18	HG2	1453.988	1446.000	-7.988	7.988	63.808144
19	HG4	1456.116	1448.000	-8.116	8.116	65.869456
20	HG5	1417.494	1409.000	-8.494	8.494	72.148036
21	HG6	1461.107	1470.000	8.893	8.893	79.085449
22	HG7	1460.493	1467.000	6.507	6.507	42.341049
23	HG8	1462.786	1473.000	10.214	10.214	104.325796
24	HG11	1427.591	1423.000	-4.591	4.591	21.077281
25	HG14	1428.512	1419.000	-9.512	9.512	90.478144
26	HG15	1393.873	1404.000	10.127	10.127	102.556129
27	HG16	1394.39	1404.000	9.610	9.61	92.3521
28	HG17	1395.123	1395.000	-0.123	0.123	0.015129
29	HG18	1395.97	1390.000	-5.970	5.97	35.6409
30	ZELEKE2	1435.61	1427.000	-8.610	8.61	74.1321
31	TW3	1366.793	1365.000	-1.793	1.793	3.214849
32	THG3	1386.62	1383.000	-3.620	3.62	13.1044
33	K1	1460.348	1452.000	-8.348	8.348	69.689104
34	K5	1457.681	1466.000	8.319	8.319	69.205761
35	K6	1459.998	1463.000	3.002	3.002	9.012004
			sum	-29.436	195.454	1541.195
			sum/35	-0.841	5.584	44.034
			SQRT			6.63582364

## Appendix D Groundwater Abstraction

**Table D.1** The estimated amount of abstracted water used in scenario-one

Well ID	Discharge(l/s)	Jan (24*6hrs)	Feb (24*12hrs)	Mar (24*16hrs)	Apr (24*16hrs)	May (24*14hrs)	Jun (24*12hrs)	m3/annual	m3/day
HG1	51	26438	52877	70502	70502	61690	52877	334886	917
HG2	51	26438	52877	70502	70502	61690	52877	334886	917
HG6	50	25920	51840	69120	69120	60480	51840	328320	900
HG7	50	25920	51840	69120	69120	60480	51840	328320	900
HG8	50	25920	51840	69120	69120	60480	51840	328320	900
HG9	10	5184	10368	13824	13824	12096	10368	65664	180
HG10	34	17626	35251	47002	47002	41126	35251	223258	612
HG12	50	25920	51840	69120	69120	60480	51840	328320	900
HG13	50	25920	51840	69120	69120	60480	51840	328320	900
HG16	25	12960	25920	34560	34560	30240	25920	164160	450
PK2	80	41472	82944	110592	110592	96768	82944	525312	1439
PK7	40	20736	41472	55296	55296	48384	41472	262656	720
PK9	50	25920	51840	69120	69120	60480	51840	328320	900
TK1	75	38880	77760	103680	103680	90720	77760	492480	1349
THG4	62	32141	64282	85709	85709	74995	64282	407117	1115
PHG1	50	25920	51840	69120	69120	60480	51840	328320	900
PHG3	50	25920	51840	69120	69120	60480	51840	328320	900
PHG5	57	29549	59098	78797	78797	68947	59098	374285	1025
PHG7	51.6	26749	53499	71332	71332	62415	53499	338826	928
TW1	7	3629	7258	9677	9677	8467	7258	45965	126
Zeleke 1	50	25920	51840	69120	69120	60480	51840	328320	900
WG1	51	26438	52877	70502	70502	61690	52877	334886	917

WG2	40	20736	41472	55296	55296	48384	41472	262656	720
WG3	7	3629	7258	9677	9677	8467	7258	45965	126
WG4	52	26957	53914	71885	71885	62899	53914	341453	935
WG5	52	26957	53914	71885	71885	62899	53914	341453	935
WG6	50	25920	51840	69120	69120	60480	51840	328320	900
WG10	50	25920	51840	69120	69120	60480	51840	328320	900
WG14	25	12960	25920	34560	34560	30240	25920	164160	450
WG15	10	5184	10368	13824	13824	12096	10368	65664	180
PK5	30	15552	31104	41472	41472	36288	31104	196992	540
TWJ4	60	31104	62208	82944	82944	72576	62208	393984	1079
<b>Kobo town water supply bore holes</b>									
K42	4.5		4.5 x 8hrs x365d					47304	130
K5	38		38 x 8hrs x365d					399456	1094
K6	38		38 x 8hrs x365d					399456	1094

**Table D.2** The estimated amount of water abstracted from 70 boreholes in scenario-two

Well ID	Discharge(l/s)	Jan (24*6hrs)	Feb (24*12hrs)	Mar (24*16hrs)	Apr (24*16hrs)	May (24*14hrs)	Jun (24*12hrs)	m3/annual	m3/day
HG-1	51	26438	52877	70502	70502	61690	52877	334886	917
HG-2	51	26438	52877	70502	70502	61690	52877	334886	917
HG3	20	10368	20736	27648	27648	24192	20736	131328	360
HG4	51	26438	52877	70502	70502	61690	52877	334886	917
HG-5	50	25920	51840	69120	69120	60480	51840	328320	900
HG-6	50	25920	51840	69120	69120	60480	51840	328320	900
HG-7	50	25920	51840	69120	69120	60480	51840	328320	900
HG-8	50	25920	51840	69120	69120	60480	51840	328320	900
HG-9	10	5184	10368	13824	13824	12096	10368	65664	180
HG-10	34	17626	35251	47002	47002	41126	35251	223258	612
HG11	50	25920	51840	69120	69120	60480	51840	328320	900
HG12	50	25920	51840	69120	69120	60480	51840	328320	900
HG13	50	25920	51840	69120	69120	60480	51840	328320	900
HG14	50	25920	51840	69120	69120	60480	51840	328320	900
HG-15	50	25920	51840	69120	69120	60480	51840	328320	900
HG-16	25	12960	25920	34560	34560	30240	25920	164160	450
HG-17	50	25920	51840	69120	69120	60480	51840	328320	900
HG-18	50	25920	51840	69120	69120	60480	51840	328320	900
Zeleke1	50	25920	51840	69120	69120	60480	51840	328320	900
Zeleke2	50	25920	51840	69120	69120	60480	51840	328320	900
PHG1	50	25920	51840	69120	69120	60480	51840	328320	900
PHG2	45	23328	46656	62208	62208	54432	46656	295488	810
PHG3	50	25920	51840	69120	69120	60480	51840	328320	900
PHG4	45	23328	46656	62208	62208	54432	46656	295488	810

PHG5	57	29549	59098	78797	78797	68947	59098	374285	1025
PHG6	58.5	30326	60653	80870	80870	70762	60653	384134	1052
PHG7	51.6	26749	53499	71332	71332	62415	53499	338826	928
PHG8	46.4	24054	48108	64143	64143	56125	48108	304681	835
PHG9	53.5	27734	55469	73958	73958	64714	55469	351302	962
PHG10	59.5	30845	61690	82253	82253	71971	61690	390701	1070
TW1	7	3629	7258	9677	9677	8467	7258	45965	126
TW3	29	15034	30067	40090	40090	35078	30067	190426	522
THG1	32	16589	33178	44237	44237	38707	33178	210125	576
THG3	57	29549	59098	78797	78797	68947	59098	374285	1025
THG4	62	32141	64282	85709	85709	74995	64282	407117	1115
TK1	75	38880	77760	103680	103680	90720	77760	492480	1349
TK7	50	25920	51840	69120	69120	60480	51840	328320	900
PK1	55	28512	57024	76032	76032	66528	57024	361152	989
PK2	80	41472	82944	110592	110592	96768	82944	525312	1439
PK3	70	36288	72576	96768	96768	84672	72576	459648	1259
PK4	60	31104	62208	82944	82944	72576	62208	393984	1079
PK5	30	15552	31104	41472	41472	36288	31104	196992	540
PK6	40	20736	41472	55296	55296	48384	41472	262656	720
PK7	40	20736	41472	55296	55296	48384	41472	262656	720
PK8	50	25920	51840	69120	69120	60480	51840	328320	900
PK9	50	25920	51840	69120	69120	60480	51840	328320	900
WG1	51	26438	52877	70502	70502	61690	52877	334886	917
WG2	40	20736	41472	55296	55296	48384	41472	262656	720
WG3	7	3629	7258	9677	9677	8467	7258	45965	126
WG4	52	26957	53914	71885	71885	62899	53914	341453	935
WG5	52	26957	53914	71885	71885	62899	53914	341453	935
WG6	50	25920	51840	69120	69120	60480	51840	328320	900
WG7	50	25920	51840	69120	69120	60480	51840	328320	900

WG8	50	25920	51840	69120	69120	60480	51840	328320	900
WG9	30	15552	31104	41472	41472	36288	31104	196992	540
WG10	50	25920	51840	69120	69120	60480	51840	328320	900
WG11	50	25920	51840	69120	69120	60480	51840	328320	900
WG12	50	25920	51840	69120	69120	60480	51840	328320	900
WG13	50	25920	51840	69120	69120	60480	51840	328320	900
WG14	25	12960	25920	34560	34560	30240	25920	164160	450
WG15	10	5184	10368	13824	13824	12096	10368	65664	180
TWJ2	15	7776	15552	20736	20736	18144	15552	98496	270
TWJ3	60	31104	62208	82944	82944	72576	62208	393984	1079
TWJ4	60	31104	62208	82944	82944	72576	62208	393984	1079
<b>Kobo town water supply bore holes</b>									
K1	10		10 x 8hrs x365d					105120	288
K5	38		38 x 8hrs x365d					399456	1094
K6	38		38 x 8hrs x365d					399456	1094
<b>Kobo Rural Water Supply bore holes</b>									
K37	2.5		2.5 x 8hrs x365d					26280	72
K38	4.2		4.2 x 8hrs x365d					44150	121
K42	4.5		4.5x 8hrs x365d					47304	130

**Table D.3** Estimating the decline groundwater level for scenario-one and scenario-two

well ID	Hs	Hm	Hs <sub>1</sub>	Hs <sub>2</sub>	Hm-Hs <sub>1</sub>	Hm-Hs <sub>2</sub>	(Hm-Hs <sub>1</sub> ) <sup>2</sup>	(Hm-Hs <sub>2</sub> ) <sup>2</sup>
PK1	1465.7	1465.000	1452.147	1434.057	12.853	30.943	165.200	957.469
PK2	1462.6	1463.000	1447.311	1427.542	15.689	35.458	246.145	1257.270
PHG1	1460.1	1462.000	1444.307	1424.826	17.693	37.174	313.042	1381.906
PHG2	1462.1	1469.000	1449.786	1432.614	19.214	36.386	369.178	1323.941
PHG3	1457.6	1457.000	1443.64	1425.378	13.360	31.622	178.490	999.951
PHG4	1466.5	1478.000	1453.099	1435.618	24.901	42.382	620.060	1796.234
TK7	1460.8	1461.000	1446.189	1425.307	14.811	35.693	219.366	1273.990
PK6	1461.4	1463.000	1446.819	1425.903	16.181	37.097	261.825	1376.187
PK7	1460	1453.000	1445.417	1424.482	7.583	28.518	57.502	813.276
PK8	1459.3	1452.000	1444.592	1423.909	7.408	28.091	54.878	789.104
PK9	1457.9	1453.000	1442.921	1422.787	10.079	30.213	101.586	912.825
THG2	1387	1379.000	1379.145	1361.212	-0.145	17.788	0.021	316.413
PHG6	1419.1	1409.000	1409.405	1389.995	-0.405	19.005	0.164	361.190
PHG8	1431.6	1433.000	1423.162	1405.347	9.838	27.653	96.786	764.688
PHG9	1435.5	1438.000	1427.456	1410.306	10.544	27.694	111.176	766.958
PHG10	1440.7	1434.000	1432.883	1416.609	1.117	17.391	1.248	302.447
HG1	1458.9	1459.000	1443.09	1423.134	15.910	35.866	253.128	1286.370
HG2	1454	1446.000	1438.24	1417.595	7.760	28.405	60.218	806.844
HG4	1456.1	1448.000	1440.312	1419.104	7.688	28.896	59.105	834.979
HG5	1417.5	1409.000	1408.456	1388.743	0.544	20.257	0.296	410.346
HG6	1461.1	1470.000	1445.133	1425.247	24.867	44.753	618.368	2002.831
HG7	1460.5	1467.000	1444.107	1423.416	22.893	43.584	524.089	1899.565
HG8	1462.8	1473.000	1447.207	1427.938	25.793	45.062	665.279	2030.584
HG11	1427.6	1423.000	1416.684	1396.496	6.316	26.504	39.892	702.462
HG14	1428.5	1419.000	1417.219	1396.825	1.781	22.175	3.172	491.731
HG15	1393.9	1404.000	1386.686	1367.127	17.314	36.873	299.775	1359.618
HG16	1394.4	1404.000	1386.686	1367.127	17.314	36.873	299.775	1359.618
HG17	1395.1	1395.000	1387.688	1367.549	7.312	27.451	53.465	753.557
HG18	1396	1390.000	1388.444	1368.26	1.556	21.740	2.421	472.628
ZELEKE2	1435.6	1427.000	1423.007	1401.851	3.993	25.149	15.944	632.472
TW3	1366.8	1365.000	1361.659	1341.15	3.341	23.850	11.162	568.822
THG3	1386.6	1383.000	1379.182	1358.752	3.818	24.248	14.577	587.966
K1	1460.3	1452.000	1444.762	1424.793	7.238	27.207	52.389	740.221
K5	1457.7	1466.000	1441.853	1421.333	24.147	44.667	583.078	1995.141
K6	1460	1463.000	1444.347	1424.307	18.653	38.693	347.934	1497.148
					398.959	1085.361	6700.732	35826.753
			ME		11.399	31.010	191.449	1023.622
			RSME				13.837	31.994

## Appendix E Radius of influence and drawdown

Table E.1 Radius of influence and drawdown

well ID	SWI	DW11	DWL2	Hm (SWL)	DD1	DD2	20% Of DD1	20% of DD2
PK1	1465.658	1452.147	1434.057	1465.000	12.853	30.943	2.5706	6.1886
PK2	1462.638	1447.311	1427.542	1463.000	15.689	35.458	3.1378	7.0916
PHG1	1460.117	1444.307	1424.826	1462.000	17.693	37.174	3.5386	7.4348
PHG2	1462.117	1449.786	1432.614	1469.000	19.214	36.386	3.8428	7.2772
PHG3	1457.581	1443.64	1425.378	1457.000	13.360	31.622	2.672	6.3244
PHG4	1466.488	1453.099	1435.618	1478.000	24.901	42.382	4.9802	8.4764
TK7	1460.849	1446.189	1425.307	1461.000	14.811	35.693	2.9622	7.1386
PK6	1461.383	1446.819	1425.903	1463.000	16.181	37.097	3.2362	7.4194
PK7	1460.036	1445.417	1424.482	1453.000	7.583	28.518	1.5166	5.7036
PK8	1459.325	1444.592	1423.909	1452.000	7.408	28.091	1.4816	5.6182
PK9	1457.864	1442.921	1422.787	1453.000	10.079	30.213	2.0158	6.0426
THG2	1386.968	1379.145	1361.212	1379.000	-0.145	17.788	-0.029	3.5576
PHG6	1419.13	1409.405	1389.995	1409.000	-0.405	19.005	-0.081	3.801
PHG8	1431.608	1423.162	1405.347	1433.000	9.838	27.653	1.9676	5.5306
PHG9	1435.519	1427.456	1410.306	1438.000	10.544	27.694	2.1088	5.5388
PHG10	1440.718	1432.883	1416.609	1434.000	1.117	17.391	0.2234	3.4782
HG1	1458.944	1443.09	1423.134	1459.000	15.910	35.866	3.182	7.1732
HG2	1453.988	1438.24	1417.595	1446.000	7.760	28.405	1.552	5.681
HG4	1456.116	1440.312	1419.104	1448.000	7.688	28.896	1.5376	5.7792
HG5	1417.494	1408.456	1388.743	1409.000	0.544	20.257	0.1088	4.0514
HG6	1461.107	1445.133	1425.247	1470.000	24.867	44.753	4.9734	8.9506
HG7	1460.493	1444.107	1423.416	1467.000	22.893	43.584	4.5786	8.7168
HG8	1462.786	1447.207	1427.938	1473.000	25.793	45.062	5.1586	9.0124
HG11	1427.591	1416.684	1396.496	1423.000	6.316	26.504	1.2632	5.3008
HG14	1428.512	1417.219	1396.825	1419.000	1.781	22.175	0.3562	4.435
HG15	1393.873	1386.686	1367.127	1404.000	17.314	36.873	3.4628	7.3746
HG16	1394.39	1386.686	1367.127	1404.000	17.314	36.873	3.4628	7.3746
HG17	1395.123	1387.688	1367.549	1395.000	7.312	27.451	1.4624	5.4902
HG18	1395.97	1388.444	1368.26	1390.000	1.556	21.740	0.3112	4.348
ZELEKE2	1435.61	1423.007	1401.851	1427.000	3.993	25.149	0.7986	5.0298
TW3	1366.793	1361.659	1341.15	1365.000	3.341	23.850	0.6682	4.77
THG3	1386.62	1379.182	1358.752	1383.000	3.818	24.248	0.7636	4.8496
K1	1460.348	1444.762	1424.793	1452.000	7.238	27.207	1.4476	5.4414
K5	1457.681	1441.853	1421.333	1466.000	24.147	44.667	4.8294	8.9334
K6	1459.998	1444.347	1424.307	1463.000	18.653	38.693	3.7306	7.7386



